

# 8 Design of river and canal structures



1

2

3

4

5

6

7

**8**

9

10

## CHAPTER 8 CONTENTS

<b>8.1 Introduction</b>	<b>970</b>
8.1.1 Context	970
8.1.2 Types of structures and functions	971
8.1.3 Design methodology	973
8.1.3.1 Approach to the design	973
8.1.3.2 Functional requirements	974
8.1.3.3 Detailed design	975
8.1.3.4 Economic considerations	975
8.1.3.5 Environmental and social considerations	976
8.1.3.6 Physical conditions	976
8.1.3.7 Materials related considerations	977
8.1.3.8 Construction related considerations	979
8.1.3.9 Operation and maintenance related considerations	980
<b>8.2 River training works</b>	<b>980</b>
8.2.1 Erosion processes	980
8.2.2 Types of river training structures	982
8.2.2.1 Revetments	983
8.2.2.2 Spur-dikes and hard points	984
8.2.2.3 Guide banks	985
8.2.2.4 Works to improve navigation	986
8.2.2.5 Flood protection	986
8.2.2.6 Selection of the appropriate solution	987
8.2.3 Data collection	988
8.2.4 Determination of the loadings	988
8.2.4.1 Hydraulic loads	988
8.2.4.2 Other types of loads	989
8.2.5 Plan layout	989
8.2.5.1 General points	989
8.2.5.2 Bank protection	990
8.2.5.3 Spur-dikes	992
8.2.5.4 Longitudinal dikes or guide banks	993
8.2.6 Cross-section design	994
8.2.6.1 Design considerations for selection of the cross-section	994
8.2.6.2 Cross-section design and typical cross-sections	1000
8.2.7 Structural details	1004
8.2.7.1 Head and berm of spur-dikes or guide bunds	1004
8.2.7.2 Crest level and width of spur and longitudinal dikes	1005
8.2.7.3 Stability of revetment toes	1005
8.2.7.4 Falling aprons	1007
8.2.7.5 Flexible open revetment	1009
8.2.7.6 Transitions	1013
8.2.8 Materials issues that influence design	1020
8.2.8.1 Materials availability	1020
8.2.8.2 Materials supply and transport	1021

8.2.9	Construction issues that influence design	1022
8.2.9.1	Approaches to construction	1022
8.2.9.2	Construction situations	1022
8.2.10	Maintenance issues that influence design	1024
8.2.11	Repair and upgrading	1025
<b>8.3</b>	<b>Navigation and water conveyance canals</b>	<b>1026</b>
8.3.1	Introduction	1026
8.3.2	Types of structures and functions	1026
8.3.2.1	Navigation canals	1026
8.3.2.2	Water conveyance canals	1027
8.3.3	Plan layout and overall concept	1027
8.3.4	Cross-section design	1028
8.3.4.1	General	1028
8.3.4.2	Navigation canals	1028
8.3.4.3	Water conveyance canals	1030
8.3.5	Structural details	1030
8.3.5.1	General	1030
8.3.5.2	Calculation of ship-induced hydraulic loads	1031
8.3.5.3	Design of the cover layer against waves	1034
8.3.5.4	Design of the filter layer	1035
8.3.6	Issues that influence design	1035
8.3.6.1	Construction issues	1035
8.3.6.2	Maintenance issues	1035
8.3.6.3	Repair and upgrading	1036
<b>8.4</b>	<b>Rock works in small rivers</b>	<b>1036</b>
8.4.1	Types of structure and functions	1037
8.4.2	Plan layout and overall concept	1038
8.4.3	Cross-section design	1039
8.4.3.1	General	1039
8.4.3.2	Forms of revetment using stone	1041
8.4.3.3	River restoration	1041
8.4.4	Issues that influence design	1043
8.4.4.1	Materials aspects	1043
8.4.4.2	Construction aspects	1043
8.4.4.3	Maintenance aspects	1045
<b>8.5</b>	<b>Special structures</b>	<b>1045</b>
8.5.1	General	1045
8.5.1.1	Water levels	1045
8.5.1.2	Current velocities	1046
8.5.2	Fishways	1046
8.5.2.1	General	1046
8.5.2.2	Recent experience with V-shape fish pass on the River Rhine	1047
8.5.3	Scour protection of bridge piers	1049

<b>8.6 Use of special materials</b> .....	<b>1051</b>
8.6.1 Grouted stone with concrete or asphalt .....	1051
8.6.1.1 Definition and use .....	1051
8.6.1.2 Dimensioning of stones and binder .....	1052
8.6.1.3 Structure specific considerations .....	1053
8.6.1.4 Other considerations for construction and maintenance .....	1054
8.6.2 Gabions .....	1055
8.6.2.1 Use of gabions for river works .....	1055
8.6.2.2 Plan layout .....	1056
8.6.2.3 Cross-section design .....	1056
8.6.2.4 Transitions .....	1060
8.6.2.5 Materials issues that influence design .....	1061
8.6.2.6 Construction issues that influence design .....	1061
8.6.2.7 Maintenance issues that influence design .....	1062
<b>8.7 References</b> .....	<b>1064</b>

# 8 Design of river and canal structures

**Chapter 8** explains how to design rock structures exposed to flows and currents in rivers and canals.

Key inputs from other chapters

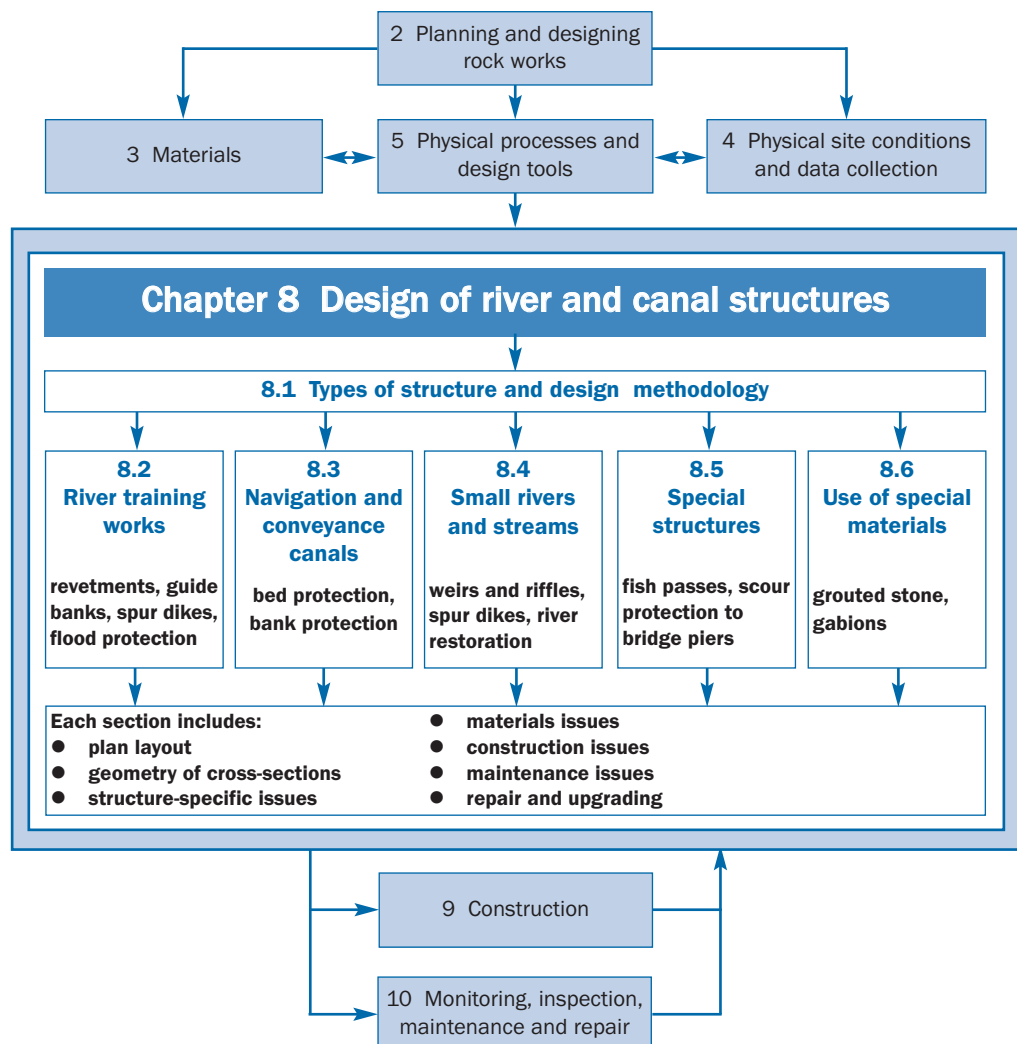
- Chapter 2 ⇒ **project requirements**
- Chapter 3 ⇒ **material properties**
- Chapter 4 ⇒ **hydraulic and geotechnical input conditions**
- Chapter 5 ⇒ **parameters for structure design**
- Chapter 9 ⇒ **construction methods and constraints**
- Chapter 10 ⇒ **maintenance considerations**

Key outputs to other chapters

- **structure design (cross-section and plan layout)** ⇒ Chapters 9 and 10

**NOTE:** The project process is **iterative**. The reader should **revisit Chapter 2** throughout the project life cycle for a reminder of important issues.

This flow chart shows where to find information in the chapter and how it links to other chapters. Use it in combination with the contents page and the index to navigate the manual.



# 8 Design of river and canal structures

This chapter examines the use of armourstone in open channels – both natural and man-made. This includes rivers, streams, drainage channels, waterways, navigation canals, irrigation canals and any channel conveying water. Closure works on open channels are discussed in Chapter 7.

The flow chart of Chapter 8 presents the organisation of this chapter. The design of river and canal rock structures follows the process identified in Chapter 2 which is revisited in Section 8.1.3.

The fundamental difference between natural channels eg rivers and streams, and artificial channels, eg canals and waterways, is that the latter are more regulated. Geometry, flow conditions and water level variations in artificial channels are often less than in natural channels and flow velocities tend to be lower. The different impacts on design of the works are discussed in this chapter.

Section 8.1 gives an introduction to structures covered in this chapter. Section 8.2 deals with structures in rivers. Section 8.3 deals with canals and water conveyance channels by stressing the differences with river structures. Sections 8.4 to 8.6 deal with the more specific issues related to some types of special structures, rock works in small rivers and specific materials.

## 8.1 INTRODUCTION

### 8.1.1 Context

Rivers and streams are dynamic entities with boundaries, such as bed and banks, which are subject to erosion and deposition. Artificial channels are often constructed using erodible materials such as existing ground or compacted earthfill. In both cases there is a need for works to stabilise the bed and banks so that the channel does not migrate and cause damage to adjacent infrastructure.

There are three main situations where protection to the bed and banks of a channel is necessary:

- in the **vicinity of structures**, such as bridges, sluices, locks and weirs, where flow velocities and turbulence are often higher, and erosion of the channel could threaten the safety or integrity of the structure
- **along a channel** where the natural material of the bed and banks could be subject to erosion, and where such erosion is unacceptable, for example, where the river or canal runs close to a road or other type of infrastructure
- **in a navigation canal** where the currents and turbulence caused by ships could erode the bed and banks. These conditions are predominantly encountered on major inland waterways in locations where large vessels dock or manoeuvre.

There are many options available to provide erosion protection to the bed and banks of open channels. Armourstone is the material most commonly used for this purpose and there are two key factors that determine which type of erosion protection is appropriate:

- the hydraulic loading
- the physical environment.

The resistance of armourstone to hydraulic loading comes from the size or mass of the individual stones and, to a lesser extent, the ability of stones to interlock. Armourstone may also be used in mattresses, eg gabions (see Section 8.6.2), allowing smaller pieces of stone for a given hydraulic loading. In general, rock is environmentally preferable to other construction materials such as steel or concrete. In addition, stone has a natural appearance, may be quickly colonised by vegetation and can provide an attractive habitat for some water species.

Investment in the infrastructure associated with rivers and canals is generally heavy, whether for maintaining inland waterways, constructing new bridges or providing flood protection works. All of these works rely heavily on the use of armourstone as an engineering material. As with any other form of construction, over the past few decades, general awareness of the social, environmental and economic aspects of civil engineering projects has improved. It is important that these factors are considered throughout the design process, in parallel with the technical issues highlighted in this manual (see Chapter 2).

### 8.1.2 Types of structure and functions

**River training** is all engineering works constructed in a river that are required to guide and confine the flow to the river channel and to regulate the riverbed configuration for effective and safe movement of water, including ice and river sediment. River training works are used to stabilise or constrain a river. They may also form part of flood alleviation works.

The most common form of training is **bank protection or revetment**, in which stones are placed on the riverbank to prevent erosion of the natural material that forms the bank (see Figure 8.1). Armourstone may be bulk placed or pitched as observed in some places in the Netherlands. Wire boxes containing smaller stones, ie gabions, may also be used as bank protection.

Where a riverbank is unstable and where insufficient space is available to allow the construction of a revetment, a **retaining wall** may be constructed. Although stone can be used in the form of masonry, this is relatively rare nowadays. It is customary to construct riverbank retaining walls from gabion baskets filled with small sized stones (see Section 8.6.2). **Gabion retaining walls** have the advantages of free drainage and the ability to support vegetation growth. Retaining walls can also be formed from large pieces of armourstone placed to form a low wall at the edge of the channel.



**Figure 8.1** Typical bank protection (courtesy Environment Agency UK)

**Groynes or spur-dikes** can also be used to reduce erosion by keeping erosive flow velocities away from the natural bank. This approach is usually only applicable to larger rivers. **Hard points** are an alternative to groynes (see Figure 8.2). **Spurs** can be used to confine the main channel of a river to improve its navigability by maintaining adequate depth of water in low

flow conditions.

River training works are applied to major structures including bridges, to ensure that the river does not migrate and outflank the structure. **Guide banks** are used extensively for this purpose, particularly in Asia. Figure 8.3 shows a typical example, which is the 3.2 km long, western guide bund for the Jamuna Bridge, Bangladesh, seen from the North (upstream) just after its completion in April 1997. The 5 km long bridge is under construction in the background. The picture is dominated by the wide, 27 m deep, trench, especially dredged to enable construction of the gentle (1V:5H to 1V:6H) under water rip-rap slope. On the slope above water the black strip of the open stone asphalt and the hand-placed rip-rap can be seen intersected by a narrow berm.

**Protection of the riverbed or scour protection** is required for structures such as bridge piers or **weirs** to prevent erosion from undermining the structure foundations. Armourstone can be used in rivers to construct weirs, although it is not always adequate to provide a sufficiently robust structure and is generally only used in cases where the drop in water level or head loss at the structure is small (say less than 0.3 m). For significant head loss, stone may be grouted or used within a concrete framework (see Figure 8.4). The detailed design of weirs is discussed in Chapter 7.



**Figure 8.2** *Hard points in Morocco (courtesy J van Duivendijk)*



Note: The dotted line represents the approximate position of the bridge

**Figure 8.3** *Large guide bund for the Jamuna Bridge in Bangladesh (courtesy J van Duivendijk)*





**Figure 8.4**

*Weir during stone placement (courtesy Environment Agency UK)*

Armourstone can also be used for rehabilitation or preservation of small rivers and artificial riffles may be built in small rivers and streams (see Figure 8.5).



**Figure 8.5** *Rock structures in a small stream to stabilise the bed and create riffles (courtesy Mott MacDonald)*

### 8.1.3 Design methodology

#### 8.1.3.1 Approach to the design

A global approach to design of rock structures is presented in Chapter 1, and more details on the planning and design of rock structures are discussed in Chapter 2 (see Section 2.2).

Armourstone used in river and canal works is an engineering material that should be specified, tested and controlled in the same way as any other construction materials. Its main properties and functions are discussed in Section 3.2 to Section 3.6. The design of the structure should follow a process in which the level of detail of the design gradually

increases. At each stage, it is essential to take into account technical issues and information at a suitable level of detail. This notably includes:

- **environmental** and social factors (see Sections 2.4 and 2.5)
- **hydraulic** loads (see Sections 4.2 and 4.3)
- **ground** conditions (see Section 4.4)
- **hydraulic** performance (see Section 5.1)
- **structural** response (see Section 5.2)
- **geotechnical** stability (see Section 5.4)
- **scour** (see Sections 5.2.2.9 and 5.2.2.3)
- **construction** issues that may influence the design (see Chapter 9)
- **maintenance** issues that may influence the design (see Chapter 10)
- availability and durability of **materials** (see Section 3.1).

The most fundamental part of the design process consists of defining the functions of the engineering works. Alternative solutions can then be compared in objective terms based on the following considerations :

- meeting the **functional requirements**, eg the stabilisation of an eroding river bank
- meeting other **design constraints**, eg the need to allow the establishment of certain types of vegetation
- meeting **other constraints** or requirements, eg optimum use of local material or minimum disturbance to leisure activities.

The design of rock structures for rivers and canals requires consideration of a number of components that constitute the whole structure, including:

- the **cover layer**, exposed to erosive forces and weathering agents
- the **underlayers**, providing a filter or transition between the armourstone cover layer and the natural soils being protected. Underlayers may comprise layers of graded stones or gravel, with or without a geotextile between the subsoil and granular filter layer
- the **ends**, eg transition with a non-protected area, and **edges** of the rock structure, eg the toe, which can be exposed to large loads, notably hydraulic ones, and can be vulnerable and susceptible to damage caused by scour or outflanking
- the **transitions** from one type of rock structure to another or from a rock structure to another type of structure. They can be either longitudinal, ie in the flow direction ( ie horizontal), or transverse, ie perpendicular to the flow direction, (ie running down the slope of a bank protection from crest to toe).

The overall design is presented in terms of its **plan form**, ie the layout of the works defining their overall dimensions and geometry, its **cross-sections**, which illustrate the composition, thickness and slope geometry of the various components of the structure, and **structural details**, such as transitions and local details at the toe or crest. The presentation of design guidance in this chapter follows this sequence.

### 8.1.3.2 **Functional requirements**

The primary functions of river or canal rock structure and associated works depend on the type of structure as already discussed in Section 8.1.2. Functional requirements are discussed in Section 2.2.2.2. Further examples of the use of armourstone in river and canal engineering are:

- **general protection** of the bed and banks of an irrigation canal downstream of a control structure such as a sluice
- **local protection** to a riverbank that is eroding towards a landfill site or an area of polluted soil
- **major river training works** upstream and downstream of a road bridge to prevent the river from **outflanking** the bridge
- creation of **environmental features** in a heavily engineered urban stream, such as small weirs and riffles
- **local protection** of a riverbank at a jetty for a ferry crossing
- **lining** of a navigable canal constructed in **erodible materials**
- **lining** structure to retain overflow during **flooding**.

### 8.1.3.3 Detailed design

At the detailed design stage, the designer should have a conceptual layout of the training works and one or more preliminary cross-sections (see Sections 8.2.6). The preliminary designs are developed to allow drawings and specifications to be produced. This is carried out in a number of successive steps, though during the process the designer may have to go back to earlier steps for amendments, and further investigation, etc. As an example, the design of a revetment, which regularly occurs, requires an iterative design procedure with the following steps:

- **Geometrical design**, including the extent of the plan layout (see Section 8.2.5), slope and crest (see Section 8.2.6)
- Selection of **revetment system** (see Section 8.2.2.1 or 8.6.1 or 8.6.2)
- **Design of the toe**, especially in relation to scour (see Section 8.2.7)
- Determination of the **stability** for the different design situations such as hydraulic loads induced by flood or navigation or other types of loads such as ice loads (see Sections 8.2.6 and 8.2.7)
- Dimensioning of **cover layers and filters** against wind and ship-induced waves and currents (see Section 8.2.7 and Section 8.3.5)
- Incorporation of revetment into local structures or vice versa.

In the specific sections of Chapter 8 mentioned above, cross-references are made to Chapter 5 that specifically deals with hydraulic performance (see Section 5.1) and structural response (see Section 5.2).

### 8.1.3.4 Economic considerations

The economics of the project can be evaluated by comparing the benefits that it provides, eg the avoidance of damage to a road running adjacent to a river, with the costs related to constructing and maintaining the works (see Section 2.2.2.5). In the case of works in rivers, scale may be a significant factor. Small-scale bank protection works on an urban stream can be very cost-effective eg if a short length of revetment on a bend protects an urban road or a sewer system from being undermined by erosion. Similar works on large rivers are frequently expensive, requiring large quantities of materials and specialised plant, eg bottom-dumping barges and floating cranes. However, it can be justified if the works protect massive infrastructure. The Jamuna Bridge in Bangladesh is an example of a major road bridge that required a huge investment in river training works in order to ensure that the river course would remain stable in the vicinity of the bridge.

The following factors have a direct impact on the practicality of implementation of a technical solution and so on the cost of the structure:

- depth and width of a channel
- height of a riverbank
- length and/or depth of bed protection
- flow velocity
- wind or ship-induced waves.

In addition, a primary factor affecting the economics of using armourstone for erosion protection is the local availability of a suitable rock source (see Section 3.1). Armourstone is costly to transport and the economics of the project are different if a suitable rock source is locally available (say at a distance of 5 km) or remote (say at 500 km from the site concerned). In such a case, an alternative solution to loose armourstone, such as grouted stone (see Section 8.6.1), gabions (see Section 8.6.2) or concrete block revetment, may be more cost-effective.

#### 8.1.3.5 **Environmental and social considerations**

The effects of the structure on the river environment and its adjacent banks should be assessed at the start of the design process. Water levels, current velocities and river morphology are environmental characteristics that may be affected (see Section 2.5). The effects on bank vegetation, fauna and landscape should also be considered.

**Some positive** effects may be expected from a rock structure when compared to other types of structures. Rock structures can be more readily integrated into the environment than concrete or steel structures. In addition, they may provide a natural surface for colonisation by vegetation and a suitable habitat for fish and other water creatures. The vegetation process can be rapid because sediment carried by the river quickly fills voids in the armourstone, providing ideal growing conditions for aquatic vegetation.

**Social factors** are vital when the river in question is used extensively for navigation, recreation or other activities, eg fishing, animal watering or washing in some developing countries. It is important to consider river uses in the early stages of planning and design, to assess the likely impacts on river usage and consider all options. Navigation rights may be protected by law, which requires extensive consultation with navigation authorities or even legal process. In the case of rivers that form important fisheries, there may be restrictions that require seasonal working, or minimisation of the disturbance to the riverbed. Access to the river to carry out the works may need careful negotiation with different landowners. Such negotiations should be carried out in the early stages of project development when there is sufficient time to consider any difficult situations.

In all cases, early **consultation** with all affected parties is invaluable to avoid potential problems and delays later in the project process, when their impact can be very costly. Early consultation also improves the chances of identifying and exploiting any opportunities for environmental or social enhancement.

**Multi-criteria analysis** (see Section 2.5) may be used as a tool by the designer to rate and assess the importance of the various aspects. It should be used at the initial selection stage to compare socially and environmentally acceptable options. This process can be used as a means of getting all interested parties to agree on the most beneficial option.

#### 8.1.3.6 **Physical conditions**

A thorough knowledge of the river or canal is required and all available data should be gathered. Additional data collection may also be required. The **geometry** of the river or canal, ie in plan view and cross-sections, is essential. It should be appreciated that many natural channels are not uniform and a complete picture of the variation in bed level and

profile, bank slope, bed slope, and plan geometry is required for the reach of river in which the works are to be constructed. Similar consideration applies to **current velocity**. The key data required for design of river and canal structures are:

- **hydraulic data** including river flows with associated water levels and current velocities (including local velocities when required). These should cover both high and low flow conditions, the latter for construction and environmental reasons (see Section 4.3)
- **river morphology**, including observations and data on erosion and deposition processes (see Section 4.1)
- **geotechnical data** is generally required later in the project development, eg to determine riverbank stability. This may be important in situations where there is a wide range of water levels in the channel, particularly if the water level can vary rapidly, or where earthquake loading is possible (see Section 4.4)
- **constraints** due to the site conditions, particularly access areas during construction (see Chapter 9)
- for wide rivers and estuarine rivers, **wave action** should also be considered (see Section 4.2)
- for rivers and canals which form major navigation waterways, details of **ship-induced loading** may be important, eg wash, waves, impact of bow-thrusters, and should therefore be considered (see Section 4.3.4).

Other characteristics of the environment may be important in specific areas, such as ice conditions, aggressive weather to be considered while selecting a solution or materials, etc.

The level of detail of site investigation should be dependent on the design stages and on the variation of the parameter or characteristic investigated (see Section 4.4 for geotechnical aspects). For example, in the specific case of river geometry investigations, for 200 m length of a river with an average channel width of 20 m, it would be appropriate to have eight cross-sections of the channel, with about 25 m spacing. A wider spacing would be acceptable if it is apparent that there is little variation in the river cross-section. Closer spacing is advised if the river geometry is complex, with great variations in bank slope or bed level or if the study is at a stage that requires increased precision.

### 8.1.3.7 **Materials related considerations**

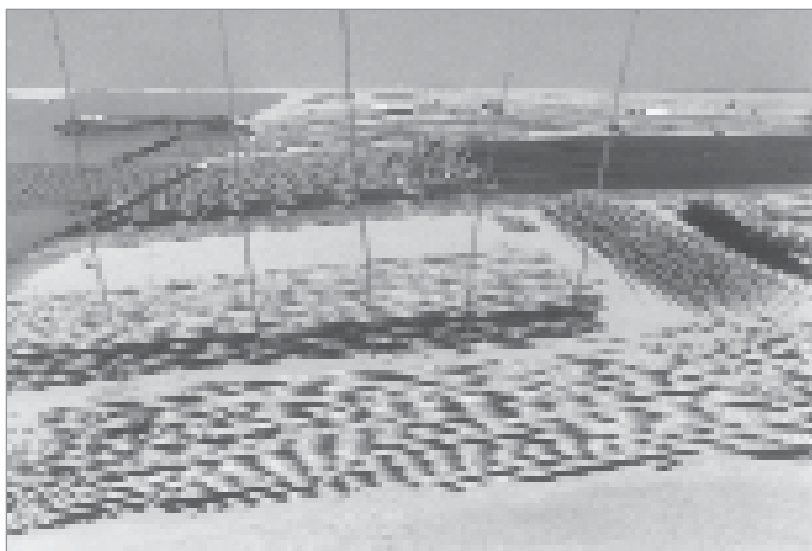
**Availability and quality** of local materials should be investigated early in the project since it is a fundamental factor in determining the economics of constructing rock structures in rivers and canals (see Section 3.1). Armourstone is most effective as a construction material when it is available locally as the transportation costs are not excessively high. However, there are situations where armourstone may need to be shipped hundreds of kilometres to the site. For example, in the case of major river works in Asia (Tappin *et al*, 1998), no source of large stones is locally available, but the construction of river training works requires large stones to resist the large hydraulic forces encountered which require long transport distances. Furthermore, structures on mountainous rivers may require large stone sizes and good durability armourstone to resist flow generated during snow melt and the resulting transport of bed stones or boulders. This may be a major issue since transport from remote quarries is difficult in mountains and subsequently very costly.

The **armourstone specifications**, especially for the grading (see Section 3.4.3) should also take into account the practicality of achieving the required grading and the practicality of checking conformity (see Section 3.10). The specification for the armourstone used should be in accordance with European regulations. However, non-standard gradings may be used and the simple approach is generally sufficient (see Section 3.4.3.9). Some designers may have non-standard approaches to designate their grading as shown, for example, in the top section of Table 8.1. The associated non-standard grading (as defined in Section 3.4.3.9) is given in the lower section of Table 8.1 and is preferable.

**Table 8.1** An example of designer-specified grading and the associated non-standard grading to use

Designer specific grading for Type A armourstone		
% of stones having a lower mass	Acceptable mass range (kg)	
	Lower limit	Upper limit
100	230	400
50	110	170
15	35	110
Equivalent non-standard grading to use (in accordance with European approach)		
Nominal limits	60	280
Extreme limits	40	420

**Associated materials** that may be available locally include **sand and gravel** for filters and underlayers. Alternatively, **geotextile filters** may be used instead of granular filters. In some cases, armourstone combined with vegetation materials may provide appropriate erosion protection, for example as fascine mattresses (see Figure 8.6), which can be made from reed, willow or bamboo. In addition, fascine mattresses may be used as stiffeners during placing of geotextiles. Nowadays geotextiles are normally used as filters but the old method of **fascine mattresses** using local brushwood contained between an upper- and lower framework of fascines is still used in some places for economic reasons (developing countries) and ecological reasons (Netherlands, Japan). Fascines are also used to place geotextiles underwater and to prevent the geotextile layers from being folded by waves and/or currents. The geotextile, provided with at least two layers of fascines – together being the geotextile mattress – is floated into position and sunk onto the bed or bank by loading it with armourstone. The use of geotextile filters for these applications should be done with great care. Wave conditions should be moderate, as the mattresses are susceptible to damage during placement (see Section 9.7.1.2).

**Figure 8.6** Construction of fascine mattress for placement of a geotextile (courtesy J van Duivendijk)

**Pitched stone** (see Figure 8.7) is hand-placed stones on a gravel underlayer. The stones are angular and regular in shape, rather than rounded, and are individually placed in one layer, wedged together with stone spalls. This provides good resistance to erosion, yet is flexible enough to accept some settlement of the foundation. The extent of the armourstone coverlayer along the slope, ie from crest to toe depends on the depth of the channel and the



degree of exposure, ie hydraulic loads such as currents, turbulence and waves. The gravel underlayer is typically 0.15 to 0.25 m thick, and construction takes place in the dry. This placement technique is much more common where manual labour is inexpensive. It requires a supply of suitably sized armourstone, ie stone roughly cuboid with depth dimension ranging from 250 to 400 mm, and a supply of cheap labour. Given these two factors, stone pitching can provide an effective means of local erosion protection to canal beds and banks adjacent to control structures and on sharp bends. Stone pitching is rarely used to line whole canal systems. In situations where the only armourstone available is of small size, for example cobbles from the riverbed, then the use of gabions and gabion mattresses may be considered (see Section 8.6.2).

**NOTE:** A distinction should be made between pitched stone and placed block revetments, such as revetments with basalt blocks or concrete elements. This type of material for slope protection is outside the scope of this manual.



**Figure 8.7** *Revetment made of pitched stone (courtesy J van Duivendijk)*

### 8.1.3.8

#### **Construction related considerations**

The consideration of how works are to be constructed is a fundamental part of the design that should take place early in the design process, to avoid pursuing options that are impractical or unacceptably expensive. This should include consideration of construction risks (see Section 9.5) and health and safety issues (see Section 2.6).

Key factors in river work construction include the seasonal variation of flow and water level conditions. Rivers have highly variable flows but with an underlying seasonal trend such as higher flows in the winter months in Europe, possible high flow in spring in mountainous areas or monsoon governed regimes in some parts of Asia. Generally, it is easier to construct in rivers when the flow is low and water depths are relatively small. The risk of rapid flooding with high velocities and water levels should be considered.

In situations where it is impossible to predict flow and water level conditions with any certainty, it is important to plan the construction works in such a way that rapid changes in hydraulic conditions do not cause excessive damage to the work in progress. Wherever possible, critical activities requiring accurate placement of stones or using vulnerable plant should be carried out at times when river conditions can be confidently predicted. This may conflict with other factors such as the environment, eg risk of water pollution in low flow conditions. In this case, early resolution of the conflict will be beneficial to all parties.

In Europe the winter season could present substantial construction challenges, not only due to higher flood risk, but also risks associated with freezing temperatures and ice in the flow.

Access to the works is a primary issue when selecting appropriate construction methods, whether this is by road or by water-based transport. Load limitations on roads and bridges, available draughts for vessels transporting armourstone, suitable sites for loading, off-loading and storage of all materials and seasonal constraints on the use of waterways all require investigation (see Section 9.2).

### 8.1.3.9 **Operation and maintenance related considerations**

The future management requirements of any structure after completion should be considered at the design stage. These assumed future management options should be realistic, achievable throughout the project life and when possible discussed with the future structure owner. The following aspects should be studied:

- **capacity of the owner** to carry out maintenance and repair work such as budgets, staff
- risk of **weathering** or poor **durability** of structural components such as armourstone, geotextile (if exposed to UV light), and steel (if exposed to corrosion)
- **vandalism**, such as removal of revetment elements, which can be serious in some situations
- clearance of **vegetation** if necessary to maintain flood capacity
- **equipment, instruments and personnel** needed locally for inspection, monitoring and reporting of damage.

In general, the higher the capital cost of river engineering works, the lower the maintenance costs. To achieve an appropriate balance between capital and maintenance costs it is necessary to investigate the likely maintenance requirements of any of the options being considered during the design development. In some cases the opportunities for carrying out maintenance activities may be severely restricted for example on a busy navigation canal, or a perennial irrigation canal. In such cases additional investment in the capital works to reduce the need for maintenance may be justified (see Sections 2.3.3 and 10.2).

To develop an appropriate inspection and maintenance plan, possible areas of degradation or failure of the structure should be identified, including the mechanisms as discussed in Section 2.3.1. A comprehensive discussion on maintenance is given in Chapter 10.

## 8.2 **RIVER TRAINING WORKS**

The design of a river training structure follows successive steps as shown on the flow chart presented at the beginning of Chapter 8.

### 8.2.1 **Erosion processes**

Erosion processes are essentially induced by high water velocity, high turbulence and high shear stress. The nature and origin of bank material as well as the processes affecting surface erosion of unprotected banks are key considerations in the selection and the design of river training works.

In some parts of the world, tides can be responsible for very large variations of sea water level and for reversal of current direction in rivers/channels. Tidal reaches can extend for several tens of kilometres and in these areas the design of armourstone revetments, toes and scour protection should consider the following points (after Escarameia, 1998):



- the **variation in water level** during the tidal cycle implies that protection of the upper part of the banks will generally be necessary with a similar degree of care as for the lower part, where tidal effects are present. Furthermore, excessive hydrostatic pressures may build up behind a bank revetment if an adequate filter layer or geotextile is not in place
- due to **flow reversal in the vicinity of hydraulic structures** care should be taken to protect banks and bed not only on the downstream side but also on the upstream side. This includes the edge details at both ends
- in **alluvial rivers under tidal flows** the instability of the ebb and flood channels can have effects on the design of the bed and toe protection
- **natural habitats** in tidal reaches are different from those in other river reaches because fine silt deposits on upper banks encourage the establishment of molluscs and slimes. The design of revetments needs to be sympathetic to this.

Sporadic discharges, such as water releases from reservoirs or intermittent discharges from power plants can, in addition to the destabilising action of the currents generated, produce significant differential loads between the front and the back of a bank revetment. This arises in particular when the permeability of the base soil differs significantly from that of the revetment.

This section presents a brief overview of erosion processes and the reader interested in more details on this topic could refer to Hemphill and Bramley (1989). It is generally convenient to classify riverbanks as follows:

- **cohesive** banks in which there is a significant amount of clay. Some peats can also be grouped under this heading.
- **non-cohesive** banks having little or no cohesion, ie those with a small amount of clay, and generally comprising sand or gravel
- **composite** banks having a layered structure, eg a cohesive soil overlying a non-cohesive soil.

There are also **bed rock** riverbanks that do not suffer from erosion in normal engineering time scales.

Composite banks (see Figure 8.8) are commonly found in rivers transporting bed material. The lower section of the bank consists of sediment that is compatible with the bed material and represents an earlier bar deposit. The upper bank consists of sediment which is not found in any significant quantity on the bed of the channel and results from the deposition of fine sediment on the bar surface during flood recession. When successive layers of cohesive and non-cohesive material are present, the composite bank is often known as layered bank. Vegetation helps to stabilise the material and encourages further deposition by increasing the local hydraulic roughness.

1

2

3

4

5

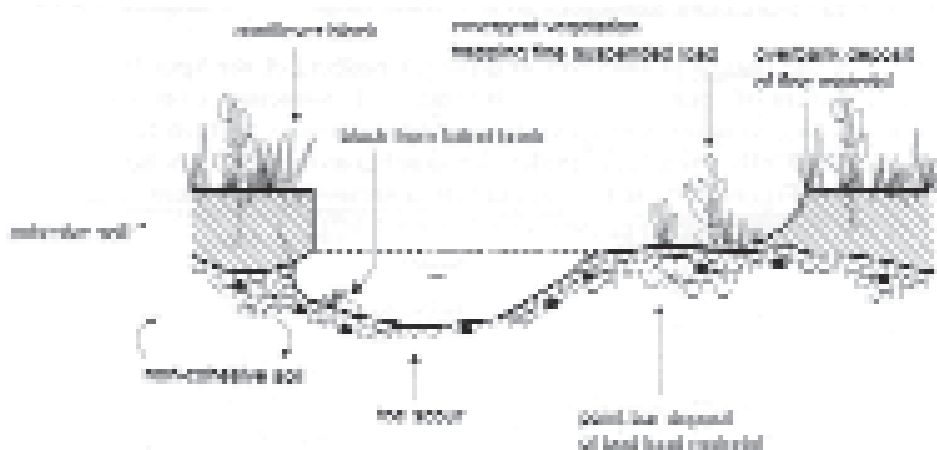
6

7

8

9

10

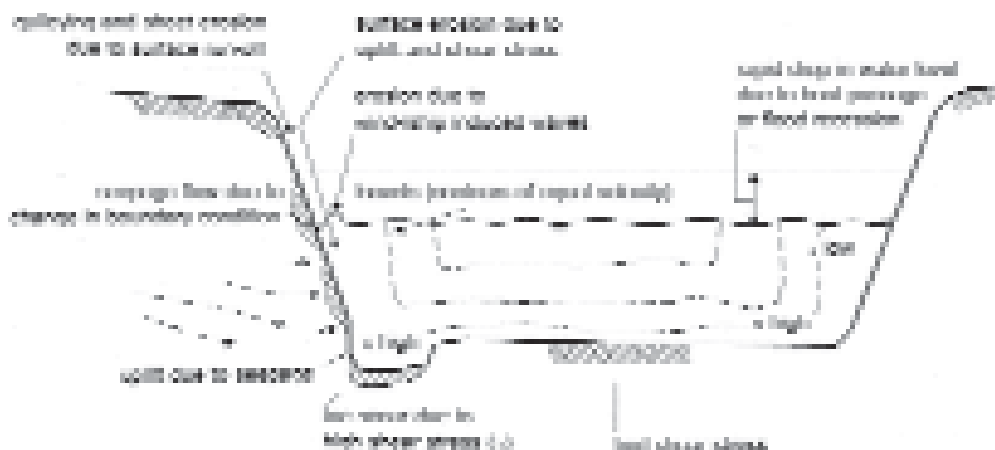


**Figure 8.8** Composite banks having a layered structure showing a varying response to erosive forces

Rivers with sand or silt beds often have cohesive banks, including peat, which can be interbedded, especially if they flow through former glacial lake or marine deposits.

Unprotected channels in alluvial materials constantly adjust their overall shape and dimensions through erosion and deposition processes. There is often permanent instability and natural adjustment of a river towards a new flow regime. Nevertheless, some average state of the river may be defined, which is characterised by averaged values for discharge,  $Q$  ( $m^3/s$ ), and water level,  $h$  (m). The construction of river training works may influence this average state called the *regime state* leading to instability in other parts of the river bed and banks (see Section 4.1).

The main processes responsible for surface erosion are illustrated in Figure 8.9 where  $\tau$  stands for the shear exerted by the current. For more detailed discussions on erosion by currents that is the major cause of scour and bank erosion in rivers, refer to Sections 4.1 and 5.2.3.3.



**Figure 8.9** Schematic representation of surface erosion processes taking place in the cross-section of a channel

## 8.2.2 Types of river training structures

This section focuses on river training works implemented on the middle and lower reaches of rivers characterised by mild slopes, ie slopes smaller than 1:1000, current velocities,  $U$ , generally in the range of 0.5 to 3.0 (m/s) and never greater than 5 m/s, and alluvial soils with grain sieve sizes,  $D$  (mm), in the range of 0.01 to 20 mm. Engineering works in steep mountain streams with coarser bed material are beyond the scope of this manual.

River training works are constructed to constrain the river, eg to ensure navigability or to avoid excessive erosion, which consequently restricts the progression of natural changes that occur as a result of the erosion and deposition of sediment. All river training works achieve their objective by protecting erodible material in the bed and banks from the effects of high current velocities and turbulent flow.

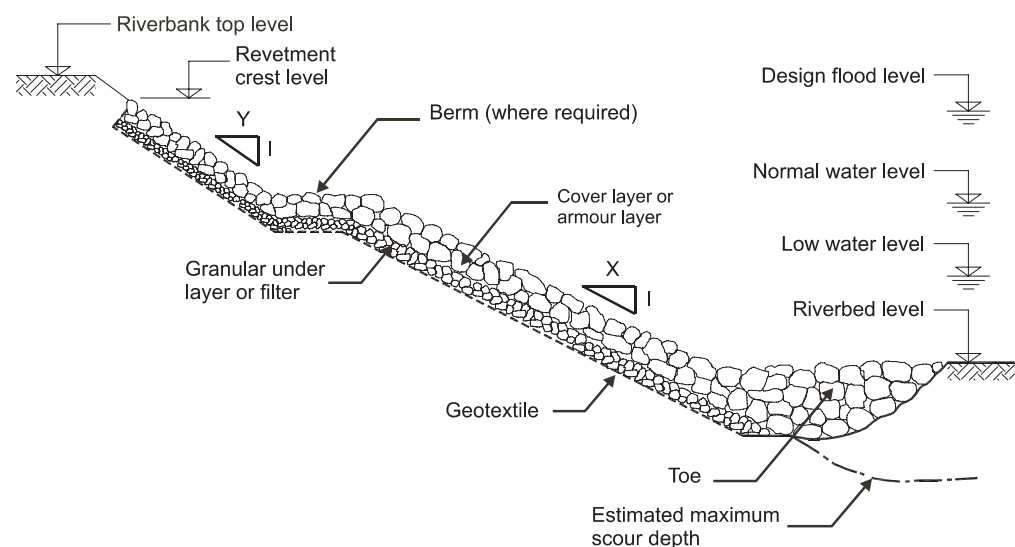
**Revetments** (see Section 8.2.2.1) provide a direct form of erosion protection to a riverbank. An alternative indirect method consists of **spur-dikes** or **groynes**, and **hard points** that deflect the erosive flow away from the bank (see Section 8.2.2.2).

### 8.2.2.1

#### Revetments

The most common form of river training structure is the **revetment** or **bank protection** (see Figure 8.10). It is composed of a layer of erosion-resistant material that covers the erodible material of the river banks, and sometimes also the bed of the river. Various materials may be used for this purpose, including grouts and geotextiles. This manual focuses on armourstone-based solutions. The choice of the most suitable material should be made at an early stage in the project. Armourstone can be directly placed onto the bank or bed to be protected. However, it is generally good practice to place it on an underlayer that provides a transition between the coarse armourstone of the cover layer and the fine erodible material of the foundation. The underlayer may be made of crushed rock or gravel that prevents subsoils from being eroded through the voids of the protection. Geotextiles may be used as a part of the filtering system, either with or instead of the granular filter (see Section 5.4.3.6). The underlayer reduces both the risk of the foundation material being washed through the armour layer and of the cover layer punching into the subsoil.

Details on other types of revetments than those using armourstone can be found in some key references such as *Protection of river and canal banks* (Hemphill and Bramley, 1989) and *Waterway bank protection* (Cranfield University, 1999).



**Figure 8.10** Components of a typical armourstone revetment

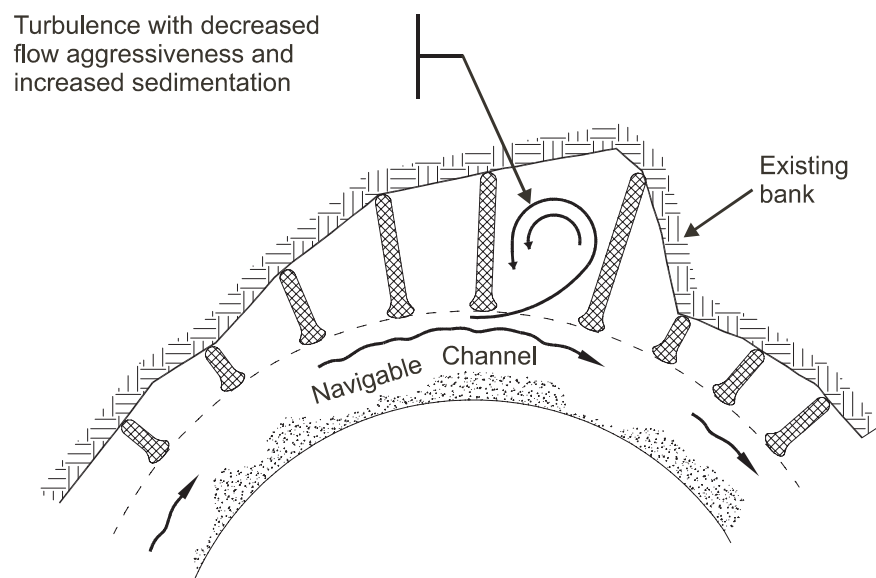
The level of the revetment toe is determined in relation to the maximum scour expected after completion of the works (see Section 8.2.6.1). A berm may be required for construction and maintenance issues (see Section 8.2.6.1 and Section 8.2.6.2). A retaining element for the toe such as a sheet pile wall may also be used and different specific structural details for revetment toes are discussed in Section 8.2.7.

### 8.2.2.2 Spur-dikes and hard points

**Spur-dikes** or **spurs** are used to restrict the width of a river channel in low flows, thereby improving its navigability (see Figure 8.11). Spur-dikes also provide an indirect method of reducing bank erosion by deflecting high velocity flow away from the vulnerable bank. They are sometimes referred to as groynes but this term is generally reserved for coastal structures. They may be used as isolated structures or within a system (see Figure 8.12). Spur-dikes are a suitable option for erosion control, but such structures generate scour at their heads. It is important that they are designed to resist scour or they may be rapidly washed away. Spur-dikes should not be viewed as an inexpensive alternative to a full revetment along the bank, if a full revetment is effectively required.



**Figure 8.11** A system of spur-dikes on the river Loire (France) (courtesy Service Maritime et de Navigation de Nantes)



**Figure 8.12** Example of plan view of a system of spur-dikes constructed to control and stabilise the erosion of the outer bend

Spur-dikes are often formed from an earth bund protected by armourstone that covers the exposed surfaces. Heavier armourstone is required at the head of the spur, ie the end that projects into the river, as the hydraulic loading is often most severe here. Specific attention should be paid to scour processes at the end of the spurs. Spur-dikes can also be constructed from gabions and gabion mattresses (see Section 8.6.2), which may be an economical form of construction when the required stone sizes are available from the riverbed.

**Hard-points** are miniature spurs (see Figure 8.13) that can help to deflect the flow from the bank to be protected. Being shorter than spurs, the distance between hard points is also reduced as appropriate. They should not be confused with spur-dikes since they are localised revetments protruding into the river. They restrict local erosion and limit the erosion in between the hard points to an acceptable degree. In contrast, spur-dikes are long compared with river width and are often exposed to severe hydraulic loading along their stems and, in particular at their heads. As such, spur-dikes are major engineering structures.

Hard points can offer an inexpensive solution for a bank protection problem, but may not provide full protection and may require additional maintenance. Hard points are not suitable where the hydraulic loads are severe.



**Figure 8.13** *Hard points under construction (courtesy Witteveen+Bos)*

**Vane-dikes** and **submerged** or **riverbed spur-dikes** should also be mentioned. Vane-dikes are low elevation structures designed to guide the flow away from an eroding bank line. The structures can be built from armourstone or other erosion-resistant material, with their crests constructed below the normal water level. They may be detached from the riverbank. Water would be free to pass over or around the structure with the main flow current directed away from the eroding bank. These structures prevent the occurrence of high erosive velocities next to an unprotected bank line, encourage diversity of channel depths (ie shallow in the vicinity of the dike and deep in the channel) and protect existing natural bank flora.

### 8.2.2.3

#### **Guide banks**

**Guide banks** may be used for the control of bank erosion at bridges, pontoons and other structures on major rivers. These are often also referred to as **guide bunds** or **longitudinal dikes**. These are major earthworks, which are crescent-shaped in plan, and are protected by revetments (see Section 8.2.2.1). They are designed to reduce the risk of the river changing course adjacent to a bridge or other structures, which may lead to outflanking.

Where guide-banks have a navigation channel control function, similar to that of spur-dikes, they may allow overtopping. Where however guide banks are constructed to prevent outflanking, overtopping under design conditions should not be allowed.

### 8.2.2.4 *Works to Improve navigation*

Works constructed in rivers to improve their use for navigation aim to provide a channel that has sufficient depth and width. In addition, the waterway should display acceptable current velocities and water level to allow safe navigation throughout the year. The provision of adequate depth and width is paramount at low discharge, whereas current velocities are a problem associated with high flows.

Spur-dikes or guide banks may be used for such purposes. By restricting the width of the river channel at low flows, spur-dikes or guide banks allow the required depth of flow to be maintained for a substantial part of the year. However, these works may restrict the flow in flood conditions that could raise water levels during floods, causing the river to breach its banks. For this reason, spur-dikes and guide-banks are often constructed to a level that overtops in flood conditions. Consequently, beacons and other safety measures may be used to ensure safety of navigation in flood conditions.

### 8.2.2.5 *Flood protection*

Flood protection is a problem associated with high water levels and, depending on the circumstances, high water velocities. The design of flood defence works is generally driven by water level rather than any considerations of erosion. Of course, as with any works in rivers, the designer should consider the need for the structure to resist the erosive forces, but this is not a fundamental objective of flood defence works. The flood wave travelling down the river requires space to expand, which results in high water levels and consequential flooding of adjacent land. Consequently, various flood alleviation measures are required and may use armourstone as a primary material. For example, flood protection dikes or banks may be constructed along the river channel where appropriate and notably in the flood plain. They may require a revetment on the side exposed to water action to prevent damage and a specific toe protection. Figure 8.14 shows the toe protection of flood protection dike under rehabilitation. The revetment and the toe protection may not be required if the flood defences are not located along the river (where high water velocities occur) but set back further inland, remotely from the river, where such flooding currents at the protection are low.



**Figure 8.14** *Flood protection dike along the Loire river under rehabilitation, notably the scour protection (courtesy TPPL France)*

In addition, flood storage reservoirs may be required and these may also need revetments on the embankment faces exposed to the flood wave. This is especially important for those exposed to wind generated waves.

### 8.2.2.6 Selection of the appropriate solution

Finding the correct solution for a particular river training problem is difficult and depends on many factors introduced in Chapter 2. In the early stages of the design development, it is useful to prepare outline designs for a number of options and compare them with reference to direct costs, durability and maintenance, environmental impact etc. Designers should note that if one option appears to be substantially cheaper than the others, it may not offer the same degree of stability, resulting in more frequent maintenance.

Revetments or bank protection are the most commonly used type of structure for river training and should be considered as the default option. However, the designer may find the following guidance helpful in identifying the most appropriate solution.

#### Revetments

Revetments are suitable in many situations where the riverbank is to be protected in its existing position, with little work needed to reform or re-shape the bank line or profile. With any revetment work there will, of course, be the need for straightening of the bank line and profile to allow the construction of the revetment to appropriate lines and levels. However, if major realignment of the bank is required it will be necessary to consider the following options:

- if the provision of a continuous revetment on the existing line of a riverbank is too expensive, the option of using hard points may be considered
- in situations where it is necessary to reinstate the river bank before protecting it, for example to reclaim lost land, a revetment may be selected as a principal solution
- however, if reinstatement is too expensive, but it is important to re-align the bank, for navigation reasons for example, the alternative of using spur-dikes should be considered.

#### Spur-dikes and hard points

Spur-dikes are suited to navigable rivers, where they can be used to define the navigable channel. They are more likely to be used on wide, shallow rivers than narrow deep channels. They are also more common on steeper, gravel bed rivers than on slower flowing channels. Effectively designed spur-dikes encourage sediment deposition between the spurs and consequently the re-establishment of an eroded bank line. Spur-dikes may not be appropriate for rivers where the variation in water level, from low flow to flood conditions, is very large.

Hard points can be used along relatively steep banks when some erosion between the hard points is acceptable. However, the alternative of using hard points instead of revetments should be carefully studied since a continuous revetment can be costly while a hard point is difficult to construct.

#### Guide bunds

Guide bunds are relatively uncommon in European rivers, but they are frequently found on major rivers in Asian countries such as India, Pakistan and Bangladesh. They are used there to constrain the river at a major structure or urban development and their classic design is for a major road or rail bridge across a river that has a history of channel movement. Guide banks in these situations are bold interventions, often requiring massive engineering works and significant investment in monitoring and maintenance. Their huge cost is justified because the risk of damage to a key infrastructure or urban settlement is significantly reduced.

### 8.2.3 Data collection

For the design of river training works it is essential that adequate data are collected for the river and locations considered. Specific attention shall be paid to seasonal variation that may require data collection during low and high flow conditions. This allows the problem to be accurately defined and the solutions to be developed with confidence.

The following items are often required for the design of river training works (the extent to which these are needed depends on the scale of the works and the design stage):

- **water level or stage** (see Section 4.1) and **flow or discharge data** (see Section 4.3.2) are commonly in the form of maximum values for a given probability of flood. But hydrographs showing the rates of rise and fall in flow and water level are also useful for planning construction works in rivers. An understanding of the rate of fall of water level following a flood is also useful in assessing the stability of river banks.
- estimates of **maximum flow velocities** in the river channel, either from direct measurements or from calculations (see Section 4.3.2.4)
- **leading dimensions** (see Section 4.1) of the reach of channel concerned, including plan form, cross-sections, bed slope and water surface slope. These data should extend upstream and downstream of the reach being considered
- the **composition of the material** that forms the bed and banks of the river, especially soil type, grain sizes and the presence of erodible layers in the banks
- any information from historic maps, aerial photographs, or local knowledge on **previous channel movements**, meander migration, patterns of accretion and erosion, shifting of channels and bypassing or cutting off of bends
- any information on **sediment transport** in the river, including particle sizes, volumes, seasonal variations (see Section 4.1.1.2)
- any information on the **use of the river** channel, which needs to be taken into account in the design, construction and maintenance of the works, such as navigation, recreation, fisheries, wildlife and water supply (see Section 2.2.2 and Section 2.6)
- details of any **tidal influences** or possible wave exposure in the lower reaches (see Section 4.2.3)
- for navigable channels, the **characteristics of the vessels** that may induce wave action at the structure.

### 8.2.4 Determination of the loadings

#### 8.2.4.1 Hydraulic loads

The hydraulic loads acting on river training works are mainly:

- **water levels** and their variations with time, notably in estuaries (see Section 4.2.2)
- **shear forces** imposed by flowing water, including turbulent flows (see Section 4.3.2.5) and **ship-induced currents** (see Section 4.3.4)
- **wind waves** (see Section 4.2.4) and **ship-induced waves** (Section 4.3.4).

To obtain design loadings, it is also important to study the timing of wind waves in relation to water levels and currents using **joint probabilities** and to choose an appropriate **return period** for stochastic variables such as wind speed and direction, water levels and related fetch lengths and current velocities.



For the design of river training works, the designer should assess the risk issues to determine the appropriate level for the design. It is common practice to adopt a return period of 100-years for flood flows in determining water levels and current velocities, however this may not be applicable everywhere. Smaller return periods may be acceptable for minor works, or where the consequences of failure are not severe (see Section 2.3.3.2).

With regard to joint probabilities, in the case of combined loadings, care should be taken not to add design loads originating from different independent phenomena. For example, a 1:100-year wind-speed and corresponding wave height may not coincide with a 1:100-year water level and related current velocity. In other words, adding forces originating from the 1:100-year wave and 1:100-year current for the design will certainly lead to significant over design because the actual probability of these two events taking place at the same time is much lower (if there is not any correlation, this probability is 1:10 000 per year).

#### 8.2.4.2 **Other types of loads**

In addition to hydraulic forces the designer should consider:

- various loads on the structure that need relevant maintenance actions and their influence on design (see Section 8.2.10)
- forces acting on the structure during construction (see Section 8.2.9)
- geotechnical types of loading (see Section 5.4).

Specific guidance is provided in Section 8.2.6.1 with reference to the design of the cross-section.

### 8.2.5 **Plan layout**

#### 8.2.5.1 **General points**

The layout of river engineering works and their functional properties depend on the characteristics of the river considered. The specific nature of each situation should be carefully considered and this section provides an *aide-mémoire* on issues that may require attention.

The importance of the river training works in relation to the river regime should be considered. The larger the intervention, the more extensive the impact will be on the river hydraulics.

Hydraulic responses of the river may include:

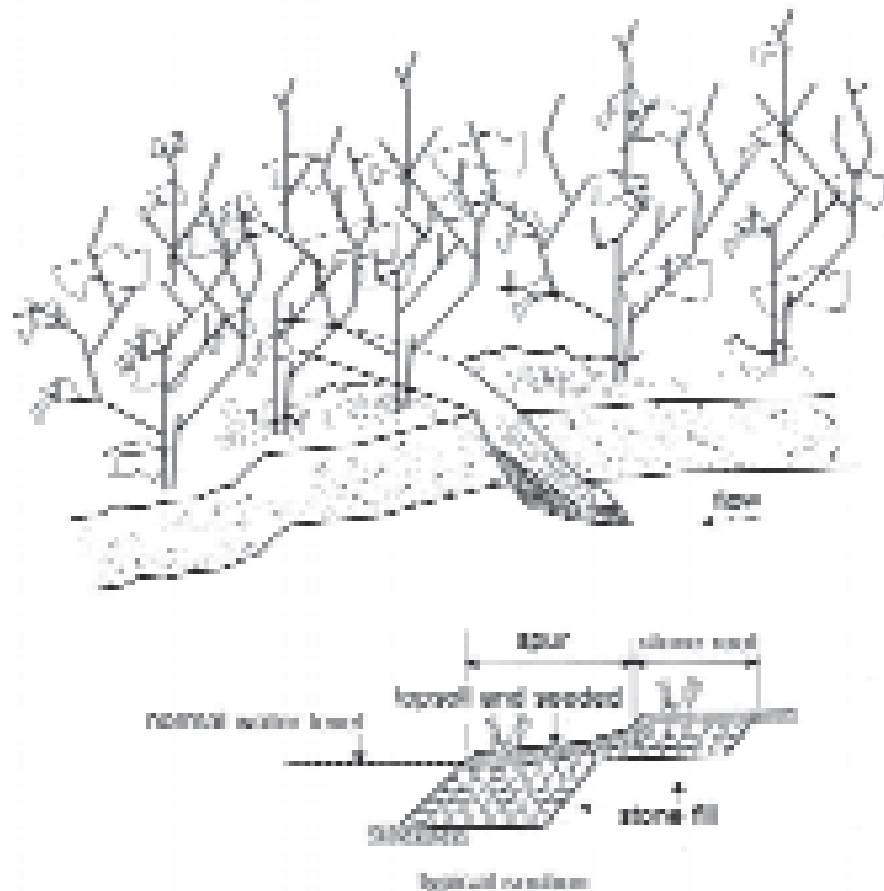
- higher current velocities in the vicinity of the structure
- increased local scour
- backwater effects
- deposition of scoured material downstream
- changes in riverbed level
- deflection of currents to unprotected sections of the river.

Each possible consequence and the associated risk should be carefully evaluated when designing the structure or when comparing alternatives. In certain situations, the detailed study may lead to a suite of structures that conform to the optimum local response as shown in Figure 8.15.



### Hard points

Figure 8.16 illustrates a typical use of hard points in the USA, used in combination with vegetation.



**Figure 8.16** Example of application of a hard point combined with vegetation in the USA

In Figure 8.16, the vegetation helps to stabilise the dumped stone by reducing the flow over the hard points in flood conditions. This type of structure may require frequent maintenance and is suited to situations where manual labour is widely available.

Hard points are also used for major local bank protection works along braided rivers, such as the rivers Brahmaputra and Lower Meghna in Bangladesh. Without protection, a shift up to 500 m per year may take place. Such hard points may protect the bank line against major shifting by braided river channels and are built at regular distances along the edge of the braid belt (ie along the permanent banks of the river between which the multiple pattern of a braided river develops). Limited bank line movement in the embayment between adjacent hard points, say up to 100 m, is acceptable at these particular locations.

The length and spacing of hard points may be determined with the same method as for spur-dikes (see Section 8.2.5.3).

The spacing between hard points is determined:

- in a **meandering river**, by the maximum embayment that is acceptable between two hard points. The method to determine length and spacing between spurs may be used to determine length and spacing of hard points (see Section 8.2.5.3).
- in a **braiding river**, by the maximum embayment acceptable in the circumstances and the possible maximum developed length of the particular shifting river channel.

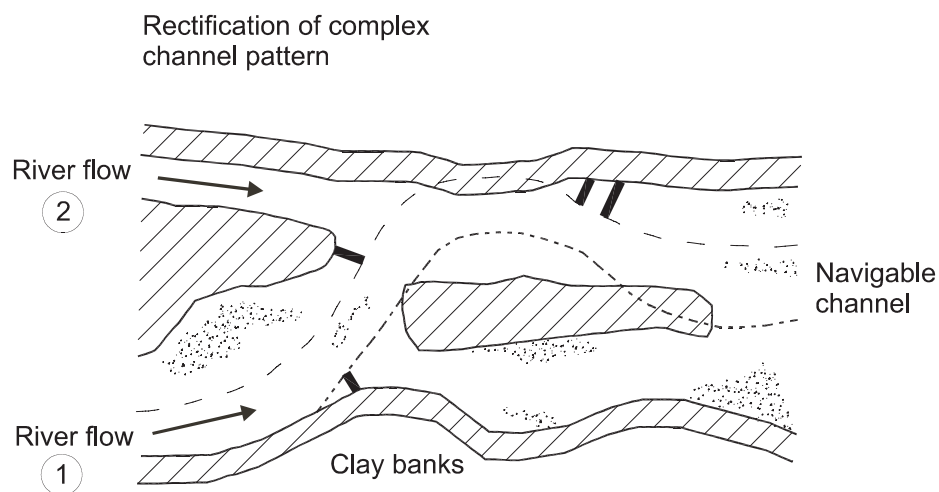
### 8.2.5.3 Spur-dikes

Spur-dikes are applied in relatively shallow rivers to maintain a narrow, deep channel for a wide range of flow conditions, particularly low flows. Spur-dikes are rather long relative to their spacing and the overall river width at bank full stage.

Spur-dikes can serve one or more of the following purposes:

- **stabilisation** of the river channel to fix the low-water channel in a favourable position
- **horizontal constriction** of the low-water channel to provide a greater depth
- **riverbank protection** by keeping the main flow away from the banks. The near-bank velocities may typically be reduced to less than 50 per cent of their original value.

The nature of the river and the purpose of the spur-dikes determine if only a few are required or if a full system of spur-dikes should be constructed. A few spur-dikes may suffice if they are appropriately located (see Figure 8.17). In other cases, a system of spur-dikes should be built on the outer bends of a river reach (see Figures 8.11 and 8.12). Finally, complete channel constriction may be required to fully satisfy navigation (see Figure 8.18) and, consequently, a series of spur-dikes is constructed along both sides of the meandering river.



**Figure 8.17** Illustration of individual spur-dikes used for rectification of a complex channel pattern

Simple rules are presented below, which are valid for a series of spur-dikes in a meandering river. They help the designer to find the appropriate spacing  $S_{SP}$  (m) and length  $L_{SP}$  (m) of spur-dikes as defined in Figure 8.18. The main flow takes place in the centre of the channel whereas turbulence occurs between the spurs, which contributes to decreasing the aggressiveness of the flow and increasing sedimentation along the bank.

#### Spacing

With a wider spacing between the spurs, the currents generated between them are stronger, with an increased risk of erosion to the exposed riverbank. The eddies between successive spur-dikes need to be strong and stable, which restricts the spur-dikes spacing. The stability of one eddy is governed by the non-dimensional spur ratio,  $e_{SP}$  (-), defined as the ratio of the head loss in the river between two spurs,  $U^2 S_{SP} / (C^2 h)$  (m), to the velocity head,  $U^2 / (2g)$  (m), of the river (see Equation 8.1), where  $U$  is the depth-averaged velocity (m/s),  $S_{SP}$  is the spacing between spur-dikes (m),  $C$  is the Chezy coefficient of the river ( $m^{1/2}/s$ ) (see Section 4.3.2.3) and  $h$  is the cross-sectional average water depth of the river (m).

$$e_{SP} = \frac{2g S_{SP}}{C^2 h} \quad (8.1)$$

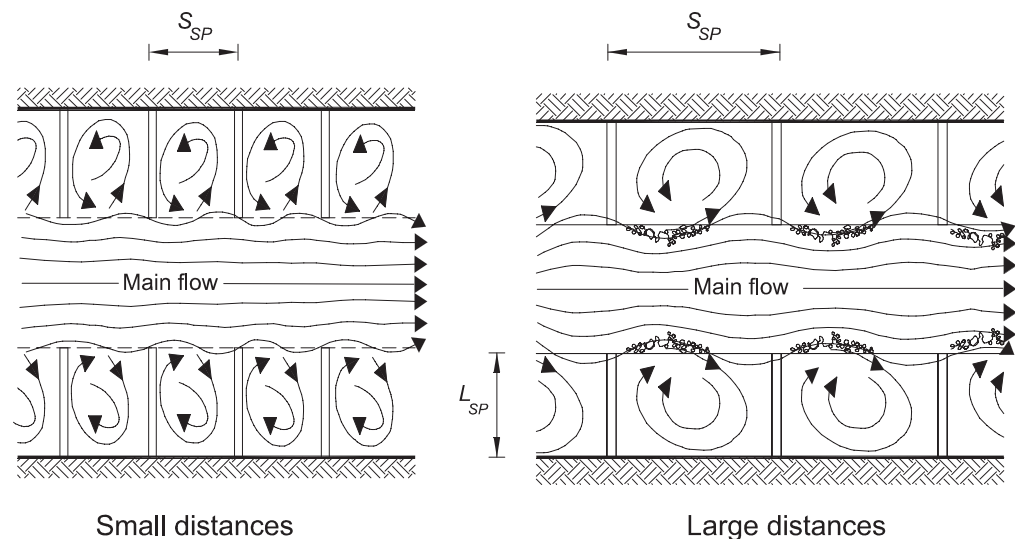
The value of  $e_{SP}$  should never exceed 1. Investigations on physical models (Delft Hydraulics, 1973) have suggested that the spur ratio should be maintained lower than  $e_{SP} = 0.6$ . In practice, an even lower limit of  $e_{SP}$  is advisable (Jansen *et al*, 1979). The distance between spur-dikes is generally determined from Equation 8.2 for stability of the eddy and from Equation 8.3 for the navigation requirement:

$$S_{SP}/B = 1 \text{ to } 2 \quad (8.2)$$

$$S_{SP}/B = 0.5 \text{ to } 2 \quad (8.3)$$

where  $B$  = width of the constricted river (m).

For larger values of the ratio,  $S_{SP}/B$  (-), acceleration and deceleration of the current display larger values that may impede navigation. This also affects construction and maintenance since large distances between the spur-dikes increase the scour forces on them, although it reduces the number of spurs. Although fewer spur-dikes are required when the spacing is increased, the cost of each spur-dike may rise as a result of increased scour protection of the head.



**Figure 8.18** Illustration of a system of spur-dikes with definitions of length and spacing of the individual dikes with respect to the river width

#### Length

Suggested values of the ratio  $S_{SP}/L_{SP}$  vary from 1 to 6 for spur-dikes in meandering rivers, for stabilisation or constriction of the channel (Jansen *et al* 1979). The function of spur-dikes in braiding rivers is to keep the flow away from the riverbank or from a bridge abutment. However, it is evident that spur-dikes are not the optimum solution in this case. Rapid shifting and the unpredictable pattern of braiding river channels means that scour will not only develop in front of the head of the spur-dike, but can also develop along the junction with the bank, making them vulnerable to damage and expensive to construct and maintain. Further details can be found in USACE (1981).

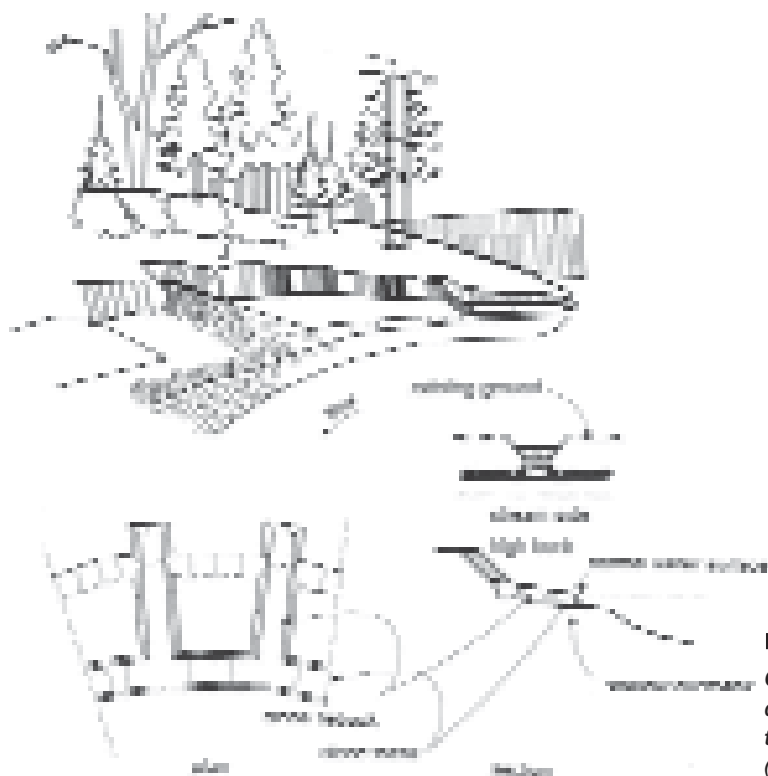
#### 8.2.5.4 Longitudinal dikes or guide banks

In a **meandering** river the choice between spur-dikes and longitudinal dikes is determined by the degree to which the channel is to be realigned. If a series of very long spur-dikes is required to reduce the curvature of a sharp meander bend as shown in Figure 8.11, a guide bank may be more appropriate and economical.

For a **braiding** river, the situation differs since contraction of flow or abrupt changes in flow direction should be avoided to limit the amount of river training works. Contraction and changes in flow direction both result in a greater scour depth that is an important parameter for design and costs.

Guide banks may be designed either to stabilise the channel or to guide the flow and they are generally located in the vicinity of major structures such as a bridge. The two distinct functional requirements are discussed below:

- **channel stabilisation:** a longitudinal dike or guide bank designed for channel stabilisation has a low submersible crest, as for spur-dikes, and is generally not continuous. It is only a few metres high and can be used in meandering rivers. Connections between the guide bank and the riverbank, also known as *cross-dikes* (Mamak, 1958) and *tie-backs* (USACE, 1981), are also low crested. These connections help to prevent erosion during high flow stages and to encourage sedimentation between the guide bank and the riverbank during the low-water period. Figure 8.19 shows cross-dikes and tie-backs in two different surroundings
- **flow guidance:** a guide bank constructed for flow guidance has a crest high enough to prevent overflow in flood conditions. In large rivers, the need for a high crest in conjunction with the possibility of deep scour at the bank toe can lead to very high banks up to 20 m or more. In such circumstances, bank protection may be a more cost-effective option. The construction of guide banks in deep water should generally be avoided.



**Figure 8.19**  
Guide bank with cross-dikes with emphasis on the use of armourstone (solution used in the USA)

## 8.2.6 Cross-section design

### 8.2.6.1 Design considerations for selection of the cross-section

A typical cross-section is composed of an armour layer with one or more sublayers between the soil to be protected and the armour. The slope of the armour may display one or more berms (see Section 8.2.6.2). The toe is generally exposed to heavy loadings and may suffer from scour. The crest level should be carefully determined taking into account whether overtopping is acceptable or not.

Rivers are dynamic entities in which the hydraulic loadings are constantly changing and the channel boundaries vary with time. The design of a revetment cross-section, which is the basis of all the river training works described in this manual, should consider the very dynamic environment in which the designed works are constructed. Design constraints are listed below and are discussed in this section:

- scour
- river morphology
- hydrology and flow regulation
- wind generated waves
- local currents and turbulence
- water level changes due to tides and wind
- ship-induced currents and waves
- ice loads
- geotechnical boundary conditions.

### Scour

River training works should be designed to resist scour, in particular erosion of the bed adjacent to the river training structure. Scour can be localised, general or a combination of both. Different terms are used to describe the various forms of scour such as *bend scour*, *constriction scour*, etc. The use of these terms can be inconsistent and the designer should carefully check the physical phenomenon behind the wording. The designer is recommended to adopt the terms used in a particular reference document such as *Manual on scour at bridges and other hydraulic structures* (CIRIA, 2002) or *Scour manual* (Hoffmans and Verheij, 1997).

The expected scour near the structure during construction and during service is one of the most important aspects to consider during design. Most failures of river training structures result from an underestimation of the depth of scour. Joint occurrence of local scour and critical morphological conditions should be considered.

To account for scour and morphological changes, the designer has three options for the toe depth of an envisaged structure (see Section 8.2.7.3 and Section 5.2.3.3):

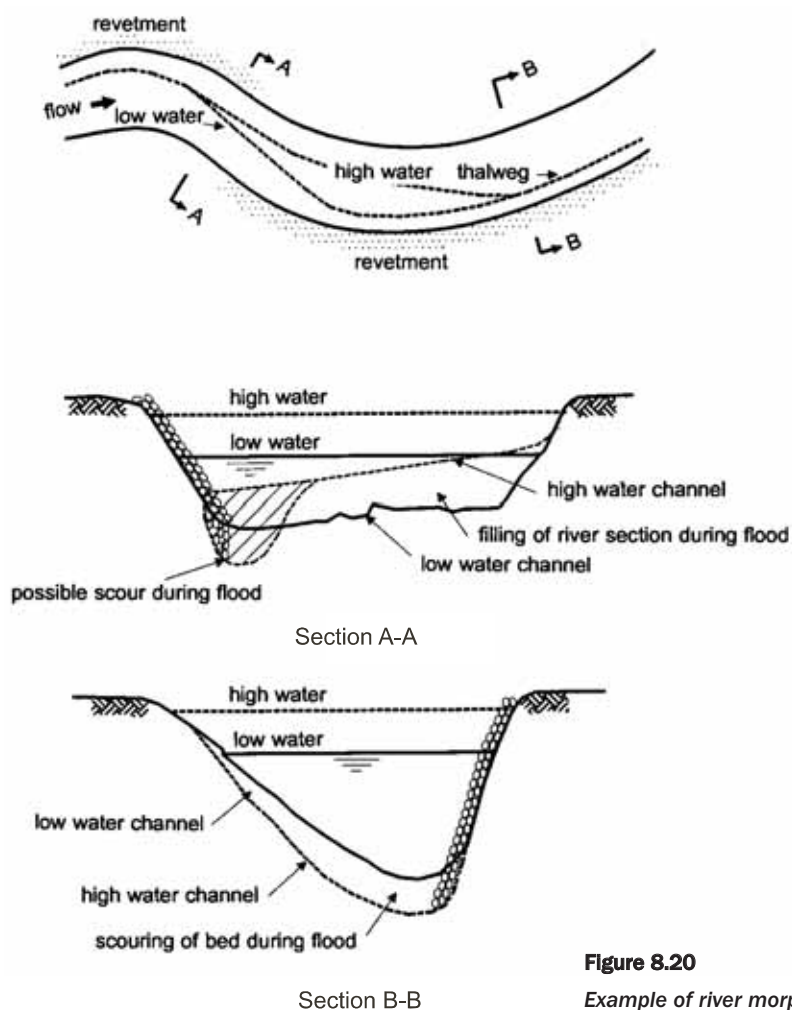
- a **toe constructed sufficiently deep**, at or below the anticipated maximum scour level
- a **toe above the maximum anticipated scour level**, but with a flexible toe protection that can respond to scour and thereby protect the revetment from being undermined. This is best achieved with dumped armourstone. Alternatives such as gabion and fascine mattresses are less flexible and may not be able to respond to local scour. However they can be used where scour is **expected to be moderate** and/or without localised deep scour holes
- a **falling apron** may also be used instead of a flexible mattress (see Section 8.2.7.4).

### River morphology

River training works have an impact on river morphology but are also affected by morphological changes of the river. A well designed revetment should resist the forces of erosion during service of the structure, provided appropriate maintenance is undertaken. However river training works are localised and rarely attempt to constrain the whole cross-section of the river or channel. Movements of the channel bed and banks may continue in non-protected areas. Bed and bank movements are more important near the boundaries of the training works, such as the toe of a revetment.

In this respect, sediment transport is not the issue to be considered when designing river training works. However, the erosion of bed or bank material and the deposition of this material elsewhere should be studied with reference to the following:

- **long-term degradation** and **aggradation** due to changes in boundary conditions and/or upstream river works
- **channel migration** upstream and downstream of the river training works
- **channel cross-section changes** due to seasonal or day-to-day variations in sediment transport and flow rate
- location of **existing revetments** or other forms of river training works.



**Figure 8.20**

*Example of river morphology changes*

Figure 8.20 shows two successive bends of a typical river channel with revetments located on the outer bank of each bend. The position of the thalweg, ie the curve connecting the deepest points in successive cross-sections, also indicates the approximate position of the line of maximum flow velocity (see the top part of Figure 8.20). The thalweg position can vary significantly, especially in large rivers and should be investigated when establishing the channel geometry. An example of how the channel cross-section is affected by changes in flow is indicated in Sections A-A and B-B. Section A-A shows how the geometry of a cross-section taken between bends changes as the discharge changes. Typically the cross-section fills during high water and scours during low water, although there is also a possibility of scour at high water downstream of the bend as shown. It may be such that the bed of large river systems (say with mean discharges larger or equal to  $10\,000\text{ m}^3/\text{s}$ ) is raised or deepens several metres during a single flood. In smaller rivers, the scour and fill may only be smaller than a metre but should be considered regardless of its magnitude. Section B-B is on the bend and shows how the river scours at high water and fills during low water.



The designer should be aware of the morphology of the river system on which the river training works are planned to be constructed. An experienced fluvial geomorphologist should be consulted to understand the river morphology, determine suitable approaches and assess the possible impact of alternatives.

### Hydrology and flow regulation

The hydrology of the river controls the hydraulic conditions to which the structure will be exposed (see Section 4.3). The hydrology of a river basin is dynamic and reliance on historic conditions may underestimate the actual flow conditions that the works will experience after construction. Changes to land use in the catchment, expansion of urban developments, climate change or implementation of river works upstream all have the potential to increase the hydraulic loading on river works. Increased loading may consist of faster currents, higher flood levels, and rapidly changing water levels, which may influence the design of the cross-section as follows:

- **increased flow currents** lead to increased size of armourstone in the armour layer and, consequently, increased thickness of the armour
- **increased flood levels** lead to increased crest level of the revetment, spur-dike or guide bank
- **increased rate of rise or fall** of water level leads to decrease of the revetment stability, especially its face slope in the event of rapidly falling water level.

### Wind generated waves

Most rivers are too small or too shallow to enable the wind to generate high waves. However on some wide rivers and estuaries, wind-induced waves may be significant and should be considered. The factors affecting these waves are wind speed, direction and duration, fetch length and the water depth. Usually, the waves can be schematised as being of a deep-water type (see Section 4.2.4). In addition to wind speed, it is important to consider duration of the wind that should be sufficient to generate waves. Brief gusts reaching high velocities do not last long enough to cause wave growth.

Wind generated waves mainly affect the crest height required to accommodate wave run-up (see Section 5.1).

### Local currents and turbulence

Current velocity is the main factor determining the size of armourstone. However, it should be appreciated that there is large variation in the current speeds in natural channels. Currents are affected by the presence of structures, obstructions and bends in the channel. These can create eddies and turbulence that are capable of imposing much greater loads on the river training works than currents alone.

These local effects can be particularly pronounced in locations where the training works provide an obstruction to the flow, such as at the head of a spur-dike. The designer should be careful when using an average current speed as the sole basis for the design. It is important to consider the likely range of current velocities, as well as the degree of turbulence that may be experienced, particularly where local obstructions or changes in geometry are likely to create eddies and local currents (see also Section 4.3.2.4 and 4.3.2.5).

### Tide and wind-induced water levels and currents

In tidal regions, daily fluctuations in water levels and tidal currents take place. In some instances, the wind may cause a shear force on the water creating a current (see Section

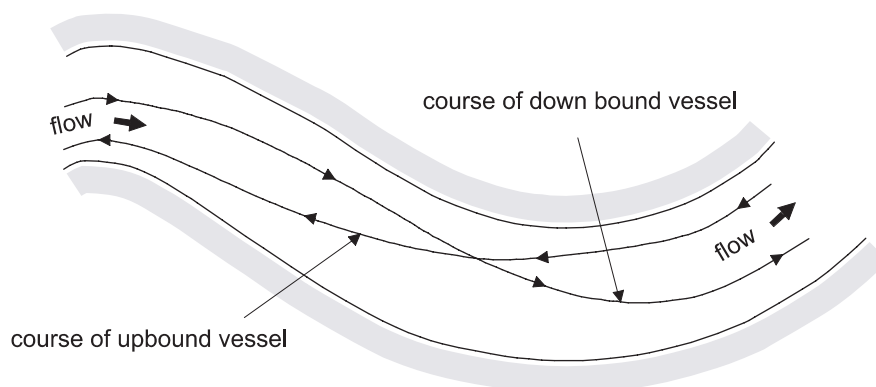
4.2.3). For steady-state conditions, the current may reach a magnitude of two to five per cent of the wind speed, whereas the effect on the water levels can usually be neglected, unless the fetch length is considerable (see Section 4.2.4.6).

#### Navigation, ship-induced currents and waves

The impacts of waves on the cross-sectional design should be considered in terms of the crest levels, slope angles and the extent of bed protection works. On rivers, the techniques of navigation vary considerably from those in a canal and should be considered accordingly in the design. Ship-induced hydraulic loadings acting on an inland waterway structure are:

- return current (see Section 4.3.4.1)
- water level depression and front wave (see Section 4.3.4.1)
- stern and secondary or interference waves (see Section 4.3.4.2).

As shown in Figure 8.21, an upbound vessel often navigates in the portion of channel where the stream velocity is lower, to save fuel and increase speed. By contrast, a vessel heading downstream generally navigates in the maximum flow. Several ship positions may need to be considered in the design. The designer should take into account local practices and regulations to establish the effect on channel and bank stability (see Section 8.3.5 for similar considerations for canals).



**Figure 8.21** Typical navigation courses

Table 8.2 indicates typical values for a number of hydraulic loads. These values should be used as a guide only. More accurate and site-specific data should be obtained for detailed design.

**Table 8.2** Typical values of hydraulic loads

Situation	Return ( $U_r$ ) or natural current	Water level depression		Secondary waves		Wind waves	
	Velocity (m/s)	Height $\Delta h$ (m)	Period $T$ (s)	Height $H_1$ (m)	Period $T$ (s)	Height $H$ (m)	Period $T$ (s)
Small river and restricted navigable channel	1.0–2.0 *	0.5–0.75	20–60	0.5	2.5	0.5	2
Large navigable channel	2.0	1.0	20–60	1.0	2.5	1.0	3–4
Large river and estuary	3.0–4.0	1.0	20–60	1.0	2.5	1.5–2.0	5–6

#### Note

\* Natural current velocities in steep upper reaches of rivers can be as much as 4 m/s.

## Ice loads

The resistance of river training works against the forces exerted by ice is of particular importance, eg along the shores of lakes and large rivers or in arctic areas. The specific problems that have to be solved in such conditions are highlighted here. Ice riding up the embankment slope may damage the armour layer and in some instances the horizontal forces may become so large that the top part of a guide bund or dike is pushed backwards – inducing *decapitation*.

### NOTE: Considerations for design with ice loads

In fact, ice has both beneficial and detrimental effects. On one hand the presence of ice limits the wave climate and erosion. On the other hand, ice can damage slope protection, and can ride up and damage surface facilities. Breakwaters designed to withstand wave attack are often able to withstand ice forces. However, there is a delicate balance between the smoothness required to encourage ice bending (to minimise the ice load and movement of individual stones) and the roughness required to dissipate wave energy.

Armourstone can be subject to normal and shear stresses along the surface. These stresses will introduce a rotation, dislodging the individual stones. It is therefore desirable that the surface of the armourstone is relatively smooth and the stone layer is well keyed. Angular stones tend to nest together and interlock. The friction coefficient of ice on rock slopes varies between 0.1 and 0.5. It is obvious that smoother stone surfaces reduce the shear stress. Another disadvantage of a rough slope with relatively large surfaces of individual stones is the possibility of rigidly frozen ice that can remove the armourstone and float it away from the site.

From experience with ice and armourstone in bank protection works several rules of thumb can be defined:

- widely graded armourstone (or rip-rap) should be avoided; standard heavy gradings are preferred (see Section 3.4.3)
- for about 0.7 m thick ice, a standard heavy grading of 300–1000 kg or greater should be used
- generally, when there are significant water level changes and concerns over plucking out of individual stones, the median nominal stone size,  $D_{n50}$  (m), should exceed the maximum ice thickness,  $t_{ice,max}$  (m)
- the slope of the armour layer should be less than 30° to minimise the shear stress
- slopes below the waterline should be less steep than slopes above the waterline to encourage rubbing and prevent ice ride-up.

Further reference is made to Section 5.2.4 and McDonald (1988), and Wuebben (1995).

Designing with the above rules of thumb in mind often implies that conflicts (of interest) arise: stability requirements lead to angular, relatively heavy stone as armouring of the revetment, whereas coping with the ice loading effects leads to a smooth surface. In that case alternative materials may be attractive, such as some types of concrete armour units (see Sections 3.12 and 5.2.2.3), concrete block or gabion mattresses, and grouted stone (see Section 3.15, 5.2.2.7 and 8.6.2).

### Geotechnical boundary conditions

The geotechnical stability of the structure, including safe slope angle, is the primary geotechnical factor influencing the design of river works. Depth and slope angle of local scour holes at the toe are important design boundary conditions that should be considered for overall bank stability as well as local stability of the toe (see Section 5.4.3.2).

Different failure mechanisms may take place (see Section 2.3) and should be studied individually or in combination. Section 5.4 presents how to address the different key geotechnical design situations that are summarised in Figure 8.22.

The global stability of the structure should be considered. This covers revetment and bank stability with reference to sliding of the slope and subsoil foundation, settlement and bearing capacity.

Local stability problems, such as local scour and internal erosion or *pip*ing, may ultimately lead to failure of the bank. Both are often initiated by excessive scour development or erosion. The possible micro-instability effects on bank erosion due to hydraulic gradient forces or rainfall run-off above the water line should be considered. If run-off is expected, it may be necessary to provide local drainage channels to allow the run-off to be disposed of without damage to the upper part of the revetment.

Frequently, local degradation or failure can be overcome by appropriate construction methods. Sound geotechnical investigations, appropriate compaction of the subsoil and geotechnical design can considerably reduce the risks of piping, migration and liquefaction.

The geotechnical stability of the underlayer is important since it provides enhanced drainage from the foundation and restrains the soil particles from being washed through the armour layer. Filter rules should be applied (see Section 5.4.3.2) and when required appropriate geotextile filters should be used.



**Figure 8.22** Riverbank subsoil failure mechanisms

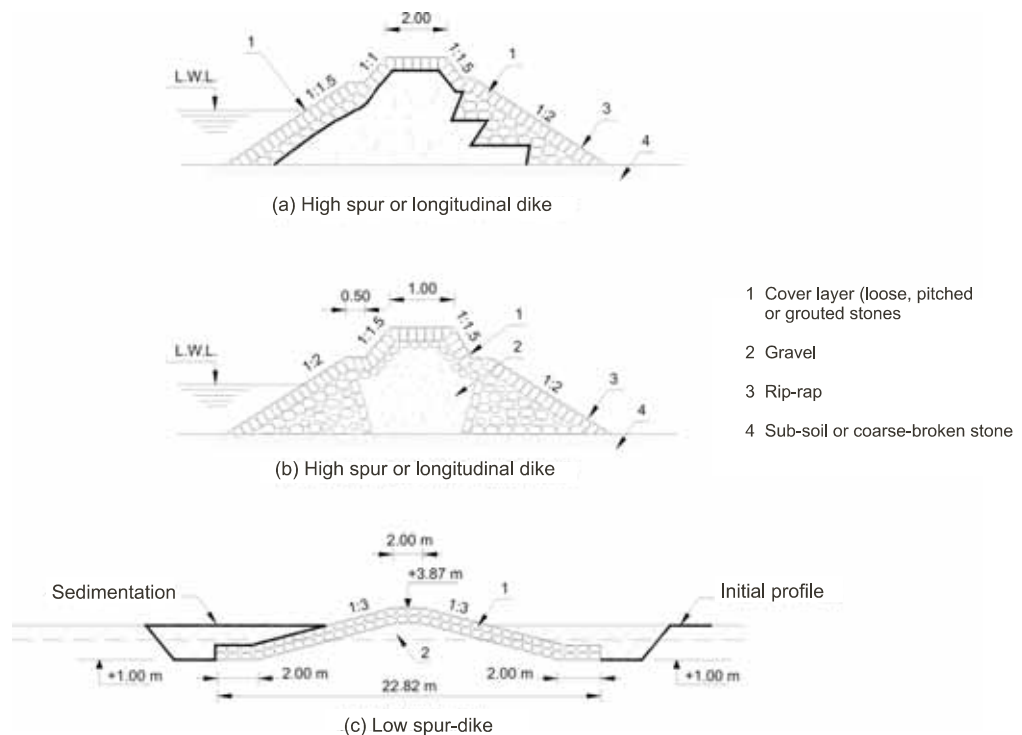
### 8.2.6.2

#### Cross-section design and typical cross-sections

There are no defining differences between the three types of river training structures, which are spur-dikes, longitudinal dikes and bank protection, in terms of their cross-sections. Figures 8.23 and 8.24 present typical cross-sections of dikes and revetments respectively. Though in principle it is possible to have another structural design than that shown, eg

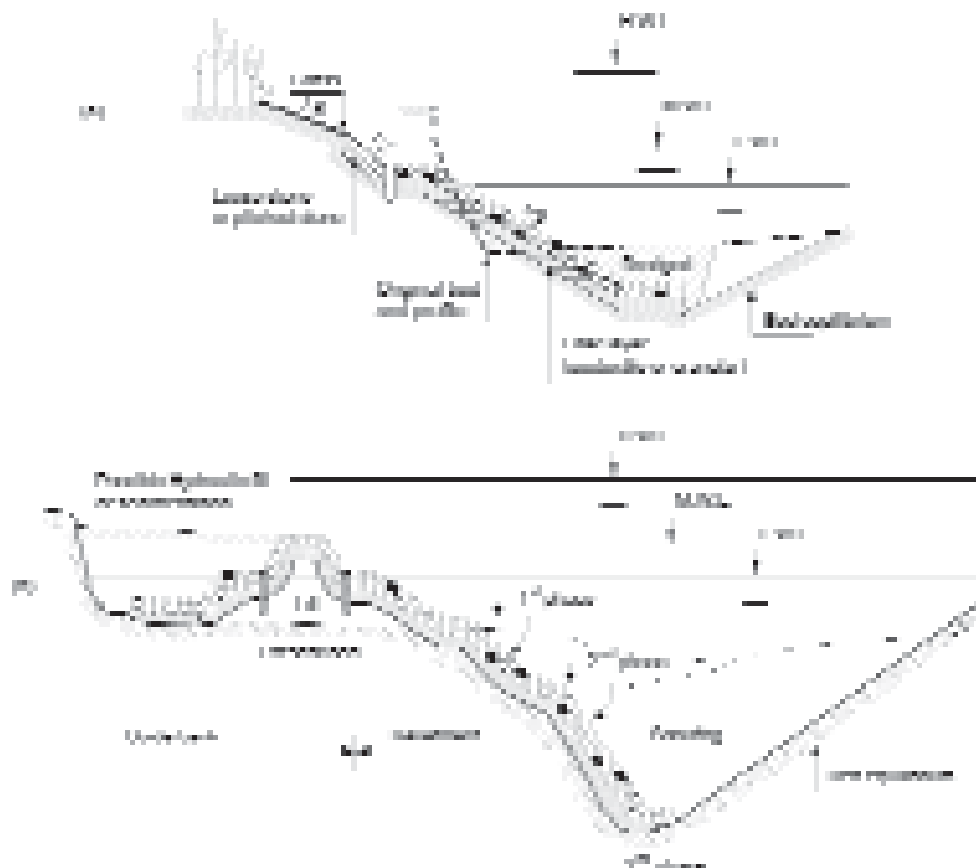
sheet-pile spur-dike, in many cases river training structures consist of an earth core or an existing slope, with a cover layer of which armourstone is a major component.

No specific distinction is made in this section between the different types of structure mentioned, since the general considerations for cross-section design are discussed here. Existing neighbouring structures at a particular site may impose geometrical constraints on the cross-section. However, with armourstone it is relatively easy to adapt the design to suit local constraints. For example, the slope of a revetment can be steepened if the size of armourstone and the thickness of the armour layer are increased. When rehabilitating an existing bank protection system, it is often cost-effective to protect the old structure as well as incorporating it into the overall concept.



**Figure 8.23** Typical cross-sections of dikes

Figure 8.23 (a) and (b) shows typical cross-sections of high spur-dikes although this cross-section could also be appropriate for a longitudinal dike. Figure 8.23 (c) shows a typical cross-section of a low spur-dike. Note that it may be built on a fascine mattress and then covered by armourstone or rip-rap. Figure 8.24 (a) and (b) shows cross-sections of bank protections. Note that both are built up in stages down to the deepest scour level.



**Figure 8.24** Typical cross-sections of revetments

The fundamental elements of a cross-section are discussed below.

### Slope and armour layer

Revetment slopes should generally not exceed 1:1.5 in a river environment and 1:2 in a marine or estuarine environment. However, it is essential that all of the following factors are considered when selecting the revetment slope for a particular project:

- the slope of the revetment should be as steep as possible to minimise the quantity of armourstone required. For example, a 3 m high revetment on a slope of 1:3 has a surface area 42 per cent greater than in the case of a 1:2 slope
- the steeper slope often requires larger stones, which should be readily available; the resulting construction thickness of the revetment will be greater
- the revetment slope also affects the wave run-up (see Section 5.1.1.2) and scour that may be increased with a steeper revetment
- safety, particularly in recreational waters, should also be considered.

The nature of the material under the revetment has a significant influence on the face slope geometry. In the case of a spur-dike constructed in the dry, the core material can be selected and compacted to achieve optimum strength (CUR/TAW 1991). The face slopes could be as steep as 1:1.5. For natural riverbanks, the usual approach is to trim the bank back to an even slope, unless the bank line is being reinstated with fill. Less steep slopes are appropriate for loose material such as sands and silts, whereas steeper slopes can be achievable in clays.

Less steep slopes should be adopted in the following situations:

- in earthquake zones

- where the water level has the potential to fall rapidly after being high for some time. This can destabilise the bank because the ground mass is saturated
- where the risk of slip failure is important, eg where the foundation soils are loosely deposited or where mica is present.

When a gentle slope cannot be achieved, alternatives should be considered and use of gabions to form a retaining wall may be considered.

Where a revetment is constructed in two or more levels, usually separated by a berm (see Figure 8.10), different slopes and types of armouring can be adopted for each of the levels. For instance, in a river environment, the upper layers of the protected soil mass may be loosely packed and more vulnerable to liquefaction in the case of earthquakes than other lower layers. The situation can be remedied by introducing a gentler slope in the upper part of the revetment. Conversely, in situations where the riverbank comprises loose sandy material overlain by layers of clay, it may be necessary to have a less steep slope on the lower part of the revetment.

### Crest level

The crest level of a revetment is normally set above the design flood level with freeboard in the order of 0.3 to 0.5 m. Larger values can be adopted in very large rivers or where wave run-up is expected. In summary, the crest level of revetments and river dikes is determined by:

- **design water** (= flood) level, which should be based on the probabilistic approach of both the river run-off discharge, the highest tidal level (HWS) in estuaries, and the wind set-up in estuaries and lakes (see Sections 4.2 and 4.3)
- **wave run-up** for which the two per cent exceedance level is often applied; this level depends on slope angle, slope roughness, existence of a berm, permeability of the structure, wave height and – period, and the angle of wave attack (see Section 5.1.1.3)
- a margin to take into account the **effects of seiches** (see Section 4.2) and gusty bumps (single waves) resulting from a sudden violent wind rush, which may vary from a few tens of centimetres to a few metres (for seiches)
- **a rise of the mean sea level due to climate changes** (see Section 4.2), which applies to estuaries and locations along rivers close to the sea
- **settlement** of the subsoil and the structure itself during its lifetime (see Section 5.4)

The combination of the above factors in a probabilistic approach defines the crest level; the freeboard,  $R_c$  (m), relative to the design water level depends on the last four of the five listed factors above.

There are circumstances where the crest level of the revetment does not need to be as high as the flood level, notably for some spur-dikes that are overtopped in floods (see Section 8.2.7.1). It is also possible for a revetment to have the critical hydraulic loading occurring at standard water levels due to currents or waves, whereas loading in flood conditions is less severe.

### Berm

A berm may be designed on the slope between the lower part and the upper part of the revetment (see Figure 8.10). A berm may be required to improve the overall stability of the works and as an alternative to flattening the face slope of the whole revetment. It may also form a transition between parts of the revetment using different types of materials or placing techniques. It may also be a means to reduce run-up when this is critical.

The level of the berm and its width is determined by its primary function:

- **wide berms** are used for access, to allow inspection and maintenance of large revetments. In this case, the berm should be at a level that allows maintenance activities a few months each year, and its width should be adequate for equipment to operate
- **smaller berms** can provide a footpath or a transition between a lower revetment on natural riverbank and the upper revetment on a constructed dike or flood bank.

For example, if the berm is used for access of vehicles, it should be sufficiently wide for access and use by plant and vehicles and set above the normal water level in the channel.

The berm level may also be determined by the water level conditions encountered during construction. For example, a berm may be formed at the transition between underwater construction and the higher part of the revetment constructed in the dry (see Figure 8.14).

### Toe

The toe is often considered to be the most important part of the cross-section, as it is fundamental to the stability of the whole structure. The toe design is discussed in detail in Section 8.2.7.3 and should be based on a reliable estimate of the maximum anticipated scour in the riverbed.

## 8.2.7 Structural details

### 8.2.7.1 Head and berm of spur-dikes or guide bunds

Spur-dikes and sometimes guide bunds can be subjected to overflow when the water level in the river is high. In the case of long revetment slopes, a berm may be included:

- for stability reasons
- to form a transition between two types of revetment armouring
- to enable maintenance to be carried out.

The 3D shaping of spur-dikes and the end of guide bunds requires special attention since an inappropriate shape can lead to pronounced vortices (or eddies) and increased scour. For the end profile of spur-dikes, slopes of 1:5 to 1:10 are commonly used for large structures. For smaller spurs, steeper slopes may be appropriate. For training works of large extent on major rivers it is important to test various design options using physical model tests. Examples of the heads of a spur-dike and the end of a guide bund are shown in Figure 8.25.

In Figure 8.25 three different views are presented:

- plan view of a guide bund in a braiding river (top left)
- plan view of a spur-dike in a braiding river (top right)
- cross-section of the end of a spur-dike in a meandering river (bottom).

On the cross-section view (see Figure 8.25 – bottom), the difference between the revetment constructed in the dry above water (above the dash line) and the revetment constructed in the wet zone (below the dash line) is noticeable. The transition between the two types of revetment is by means of a row of piles which is a solution widely used by Dutch engineers. A berm is introduced to increase the stability of the piles.



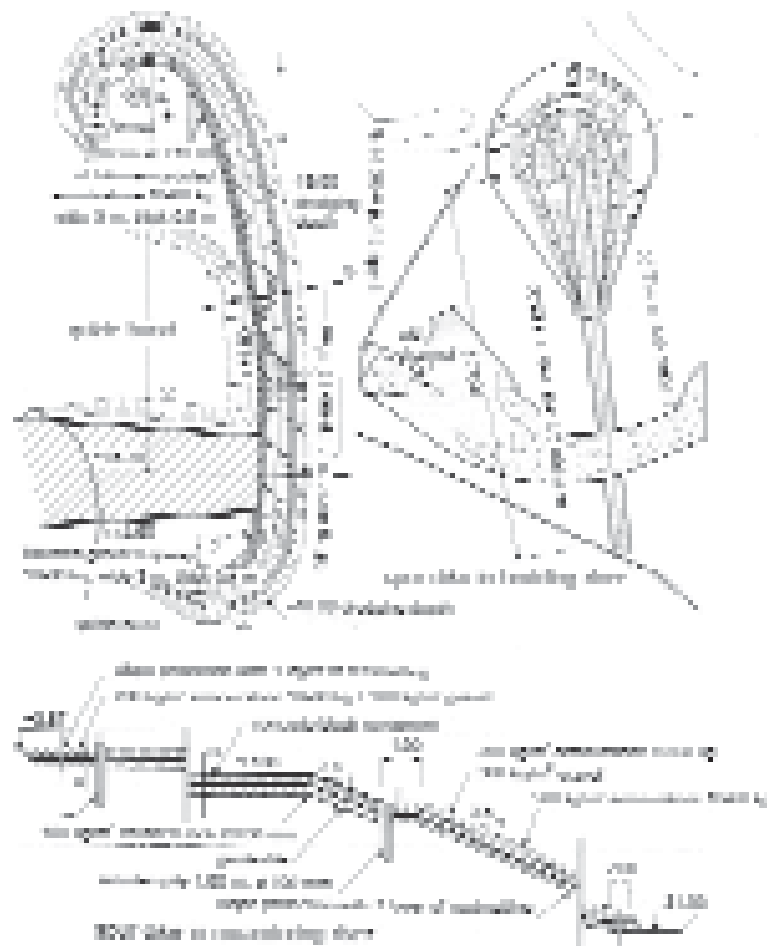


Figure 8.25

Examples of heads of spur-dikes and end of guide bunds

### 8.2.7.2 Crest level and width of spur and longitudinal dikes

The crest level of spur-dikes and longitudinal dikes with a function of channel stabilisation or constriction in meandering rivers is, apart from economic reasons, determined by navigation requirements, flood discharge factors and construction practicalities, eg placing stones on the revetment crest in the dry. This implies that the crest should be dry at normal (ie non-flood) water levels that might be expected during the construction period. The highest level is determined by the flood plain level, as at high river levels current concentration and erosion behind the structures should be avoided. The crests of spur-dikes may slope towards the river, typically 1:100 to 1:200.

The crest level of guide bunds as used in bridge projects is often much higher. Such guide bunds should keep the flow away from bridge abutments and bridge approaches and should not be subject to overflow. The height of the crest can be determined by the design water level for the whole project. Overtopping by waves may be acceptable and freeboard in this case is only required as a safeguard to unexpected settlements and to cater for inaccuracies in water level calculations.

### 8.2.7.3 Stability of revetment toes

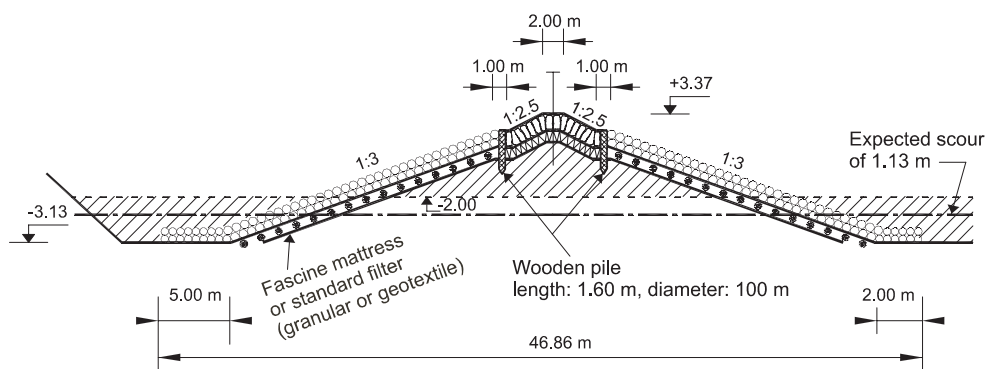
River training works may be exposed to various types of scour, depending on the nature of the river and the type and location of the structure: local, general, constriction, confluence, bend or protrusion scour (see Section 8.2.6.1 and Section 5.2.3). Not all of these types of scour will develop at any particular structure, nor do they have the same magnitude. A complicating factor is that to some extent the types of scour are inter-dependent or partly correlated. More detailed guidance on scour and engineering works to counter it can be found in Hoffmans and Verheij (1997), CIRIA (2002) and Sumer and Fredsoe (2002).

As soon as all of the calculations for the joint scour and its consequences have been verified and are to an acceptable probability of exceedance, the designer should decide what counter-measures are to be taken. There are three different solutions for the problem of scour at the toe:

**Case 1: No significant scour – no need for protection.** The revetment has its toe at the meeting point between the slope and the riverbed level and no appreciable scour, ie scour that endangers the stability of the revetment, is expected.

**Case 2: Significant scour – bed protection provided to resist scour.** The revetment has its toe at the meeting point between the slope and the riverbed level but appreciable scour is expected and appropriate protection measures should be taken on the bed.

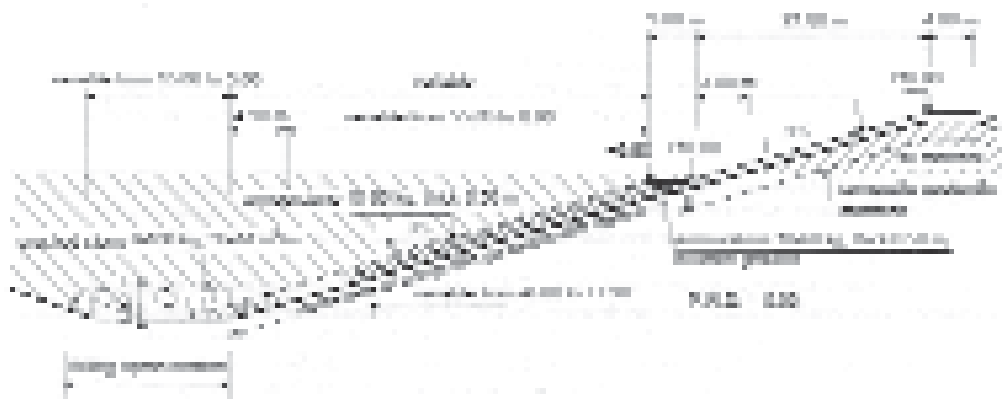
**Case 3: Significant scour – toe of revetment is extended** into the bed in anticipation of future scour: the revetment toe is placed in a trench, excavated in the riverbed, flood plain or foreshore at the time of construction, to form a falling apron.



**Figure 8.26** Toe of spur-dike showing provision for scour

No appreciable scour can generally be found along inner bends of meandering rivers and along the stems of spur-dikes. Extension of the revetment cover layer over a few metres on the horizontal riverbed is usually sufficient. In many cases, this horizontal protection is already provided by the edge of the fascine mattress or the filter layer (see Figure 8.26). When there is a risk of erosion of soil through the cover layer, extension of the filter layer should be investigated.

When there is a risk of appreciable scour or if it is expected in front of the structure, suitable measures should be taken. The designer should start by assessing the future scour depth (Hoffmans and Verheij, 1997 and CIRIA, 2002). Depending on the outcome and the local circumstances, the designer should decide if the situation is case 2 or case 3 as defined above or a combination of both. In case 2, a falling apron may be recommended (see Section 8.2.7.4). In case 3, the revetment may be extended downward in an excavated trench (see Figure 8.27). In Figure 8.27, the lower part of the revetment and the falling apron have all been placed under water. When the geotextile filter is placed under water, fascines may be added to help the placing (see Section 9.7.1.2).



**Figure 8.27** Toe of guide bund with falling apron constructed in a trench, excavated in the dry or dredged as required

This final decision on the type of counter measure to apply depends on:

- whether or not it is possible to construct a revetment in a **dry trench** down to the expected scour depth
- whether **dredging down** to future scour level is a realistic possibility, in view of costs involved, available equipment and practicality ie currents
- whether a **falling apron** (see Section 8.2.7.4) can be expected to work.

#### 8.2.7.4

#### Falling aprons

A falling apron is a ridge of armourstone dumped at the toe of a revetment. It is also known as *launching* or *launched* apron as it is *launched* as a consequence of scour. The apron is designed to fall into the scour hole when scour develops in front of the toe. The concept behind the falling apron is that it provides an armour layer on the slope of the scour hole. The width of the apron and quantity of armourstone should be sufficient to cover the entire sloping face of the scour hole when fully developed. The thickness and the grading of the armourstone should be such that, at the end of the falling process, the underlying soil is still retained by the protective layer.

Toe scour will occur along a toe structure showing a significant local variation in depth, for example in the case of outer bend scour. When selecting from the three counter measures listed above, it should be considered that a falling apron only works when it is also flexible in the direction *along* the toe structure. For this reason, an apron consisting of only wide-graded armourstone is preferable. Effectively, extra stiffness associated with additional materials such as geotextiles, fascines or gabions may hinder the apron from following local scour development and result in its failure to perform its protective function.

The designer should be very careful when extrapolating from experience obtained on other rivers and at smaller depths. Note that a falling apron automatically results in a steep revetment with a natural slope close to 1:2, which may not be stable in certain situations, eg if exposed to earthquake. A critical analysis of using a falling apron should be performed and this situation is illustrated in Box 8.1.

Falling aprons can provide significant safety against scour at the edge of structures. This safety manifests itself particularly in the form of delaying the scour process. However further monitoring of falling aprons is necessary to ensure the expected behaviour is observed and to determine if dumping of extra material is required.

**Box 8.1** Critical analysis of the use of falling aprons at Jamuna River (India)

For the Jamuna Bridge project in Bangladesh, it was originally decided to have the dredged toe of the revetment of the guide bund at 10 m below PWD, the local datum (depths are given relative to PWD = MWL - 5.9 m). Scour could develop to a depth of -25 m PWD. Accordingly, a falling apron was designed and placed at -10 m PWD with a possibility to *fall* a further -15 m. During the detailed design stage this was considered too risky and it was decided to have the falling apron operating from -18 to -27 m PWD or locally to -30 m PWD. It was felt that:

- dredging from flood plain level at +12 m down to a level of -18 m was a maximum from the perspective of cost, ie in areas of cross-section to be dredged and equipment availability
- 10 to 12 m difference in height from the level of the falling apron to the bottom of the scour hole was the maximum for reliable *apron launching* without great damage.

In the same project, at another site less vulnerable to scour, the design of the bank protection included a falling apron from +8.80 m to -20 m as it was felt that:

- it was much less probable that scour would ever develop down to that particular depth
- if it did and the apron did not function, no serious consequences were to be expected.

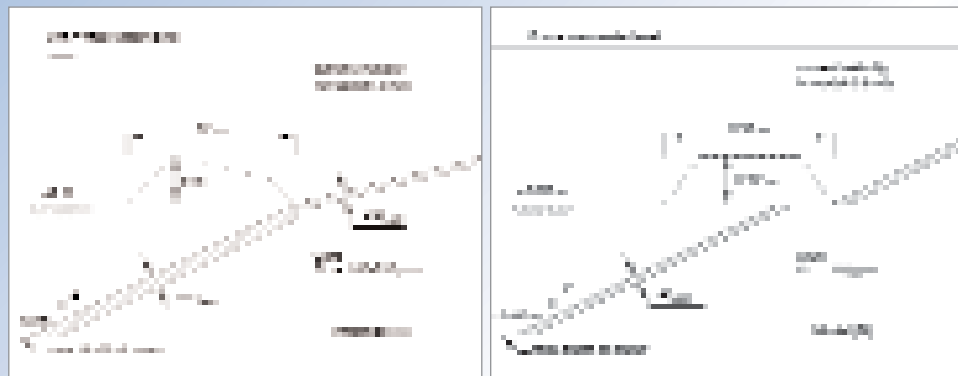
The insight provided by some preliminary research at model scale (van der Hoeven, 2002) helps to understand the settling process and settling results for falling aprons. Note that this study was performed for a specific case and variation for other situations should be expected. Key conclusions are summarised below and further details are given in Box 8.2:

- a falling apron settles evenly and over the entire slope of the scour hole as it develops. In the model, the scour hole slope was covered with armourstone at all times
- the slope is approximately 1:2. This seems to hold for both the model and prototype, and agrees with the expected steepness described in other literature
- the armourstone size does not influence the angle of the slope
- the resulting protective layer remains limited to a single layer of granular material in the model whereas the prototype displays a thicker layer of  $5 \cdot D_{n50}$
- applying a thicker apron does not lead to the formation of a thicker protective layer on the slope. However, it will slow the retreat of the apron edge
- when the falling apron is constructed in the form of a wedge towards the river, further material can be stored at the outer side. This will delay the retreat of the apron at the beginning of the settling process
- the slope protection provided by the falling apron does not protect the sand underneath the apron from being washed away. Effectively, the single layer (observed in model tests), the relatively large stones used and the openings between the stones are such that the layer cannot retain the sand. For evident practical reasons, two or more layers with different gradings cannot be introduced. It is recommended that graded armourstone, which can be closer to filter rules, is used. The solution in this particular case was to use a wide grading (1–100 kg) instead of the 10–60 kg grading on the adjacent slope.
- the slope protection restricts the transport of bed material through the layer. Although not sand-tight, the protective layer will generally limit the transport of sand from the foundation
- after reaching an equilibrium depth, the larger part of the falling apron is still unaffected. This extra quantity acts as a buffer and will be necessary when a greater depth occurs or when a river branch is adjacent to the revetment
- the falling apron is a flexible protection that can adapt to flow conditions when the river attacks at an angle. In the upstream part of the model the apron was attacked at an angle. Here the settling was even and showed the same behaviour.

When it is necessary to replenish a falling apron, the extra volume of armourstone should be dumped on the horizontal part of the apron. The settling mechanism can then distribute the stones over the slope.

**Box 8.2** Recent laboratory research on falling aprons

A pilot study was performed on the behaviour of falling aprons by testing small-scale models in the flume (van der Hoeven, 2002). The falling aprons tested were designed for the guide banks of the Jamuna Bridge project (see Box 8.1). Figure 8.28 shows the expected behaviour of the falling apron in prototype and in the laboratory.



**Figure 8.28** Expected behaviour in prototype (A) and observed behaviour (B) in laboratory test

The purpose of the laboratory tests was to:

- 1 Obtain insight into the falling process and the successive phases.
- 2 Determine whether different configurations influence the final slope ie is special care during dumping necessary.
- 3 Determine how an apron with insufficient armourstone should be re-strengthened.
- 4 Determine whether the use of a falling apron can provide a durable protection against scour.

When designing a falling apron, the following aspects should be considered. As the apron will finally be formed in the model, it will be of a single armourstone layer on a steep slope 1:2. It should first of all be checked whether the armourstone size ( $D_{n50} = 0.20$  m in the prototype) is large enough on this steep slope. A verification of the slope stability (see Box 8.3) is done, not using the revetment angle but the apron slope angle,  $\alpha = 26.5^\circ$  (1:2 slope). Considering this angle value,  $\phi = 40^\circ$  for the repose angle, and equations from Section 5.2.1.3, the appropriate strength reduction factor may be found,  $k_{sl} = 0.626$ , which then results in the appropriate armourstone size  $D_{n50} = 0.179$  m. The corresponding  $M_{50} = 15$  kg ( $D_{n50} = 0.22$  m) so a grading of 5-40 kg will suffice. A wide grading is intentionally selected to limit loss of fines from the underlying material, since a granular filter layer or geotextile under the apron is missing. An expected scour of 6 m implies a minimum volume of armourstone in the apron of  $0.22 \times 6.0 \times \sqrt{5} = 2.96$  m<sup>3</sup> per linear metre of revetment. The apron should be placed at a water depth of 15 m, necessitating high placement tolerances. The behaviour cannot be predicted in detail when a volume of 6 m<sup>3</sup> per linear metre of revetment is placed.

### 8.2.7.5 Flexible open revetment

The terminology *open revetment* is used to distinguish loose stones from fully or partly grouted armourstone. A practical design procedure for a flexible open revetment is presented here. It often takes place in successive steps described as follows:

- Step 1:** Assessment of the **erosion resistance of the non-protected** soil and determination of the area of slope to protect.
- Step 2:** **Sizing the cover layer** for stability against hydraulic loading, including wave attack above water and current attack under water.
- Step 3:** **Selection of the material** including size and durability.
- Step 4:** Design of the **filter system** and the **sub-layer**.
- Step 5:** Design of the **toe protection** and any **transitions**.

### Step 1: Erosion resistance of the non-protected soil

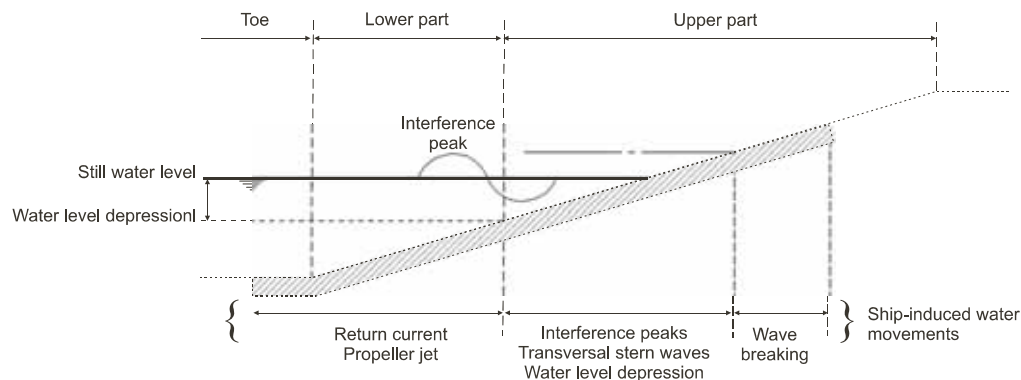
At this stage, the designer should determine where the non-protected soil may not resist hydraulic loadings and consequently the extent over which the revetment should be laid in the longitudinal direction (for the transversal direction see Step 2). The designer should consider where the limit is for the adjacent non-protected soil not to erode or, if it does, where it will not lead to collapse of parts of the revetment. In practice, hydraulic loads, including currents, wave attack, water level variations, should be assessed at the boundaries of the revetment and, more generally, for the river training structure involved:

- at the toe of a bank protection, ie scour of riverbed
- on the bank if exposed to propeller action
- on the bank, if exposed to ship-induced waves
- along the slopes of a spur-dike, ie eddies
- at the root of a spur-dike during overflow
- behind a non-overtopping guide bund, ie as a consequence of meandering or shifting river channels or eddies.

This list is not comprehensive but more of an *aide-memoire* that should be adapted to each individual situation. The reader should refer to Sections 4.2 and 4.3 (notably Sections 4.3.2.3 and 4.3.2.4) to determine the appropriate hydraulic load and to Sections 4.1.3.4 and 5.2.1.2 to verify if soil material may be eroded by water action.

### Step 2: Cover layer stability and sizing of armourstone

The stability of the revetment in river training structures should be designed for the appropriate hydraulic loadings such as currents, wind or ship-induced waves or their combination (see Figure 8.29). In wide rivers, ship-induced hydraulic loads play a lesser role (see Section 8.3). Current attack is relevant only for the underwater part of the revetment, whereas wave loading is considered for the section above water.



**Figure 8.29** Ship-induced hydraulic actions to consider for the design of the different parts of a revetment

The reader should assess the physical process that takes place and the armourstone size required. Refer to Section 5.2.1 for general introduction, Section 5.2.2 for response to waves, and Section 5.2.3 for response to currents. Where ice conditions may be expected, specific attention should be paid to ice induced load, the reader is recommended to refer to Sections 5.2.4 and 8.2.6.1.

The result of the cover layer design is typically expressed as a nominal median stone diameter,  $D_{n50}$ , required for hydraulic stability.

### Armourstone sizing against current attack

The loading considered here is the natural current. For the design of a revetment exposed to loadings due to ship-induced water movements the reader should refer to Section 8.3.6. The hydraulic stability of the cover layer is evaluated by means of deterministic calculations (see Section 2.3.3.3) based on a value of the design current. The water level during flooding is determined from Section 4.3.5. The current velocity and local current and shear are determined from Section 4.3.2.

The appropriate armourstone size may be determined using the widely used Izbash approach (see Section 5.2.1.4). More detailed or generalised equations are given in Section 5.2.3.1 from Pilarczyk (Equation 5.219), Escarameia and May (Equation 5.223) or Maynard (Equation 5.224). The results given by these three equations are compared in Box 5.24 indicating similar results for normal and more conservative results from Maynard and Escarameia and May for increased turbulence.

Box 8.3 discusses the differences of results for the design against current attack using these different methods.

### Armourstone sizing against wave attack

The dimensioning of the upper part of the revetment against wave attack may be performed using the design method presented in Section 5.2.2:

- for a straight slope of a non-overtopped structure, see Section 5.2.2.2
- for a composite slope, ie with a berm, refer to Section 5.2.2.8.

In general a statically stable design is preferred. Note that using wide grading armourstone, eg rip-rap, tends to increase damage (see discussion in Section 5.2.2.2). In addition, in estuarine rivers the ocean wave at the structure may be significantly oblique which should be taken into account (see Section 5.2.2.2).

**NOTE:** Armourstone cover layers on structures in very shallow water and gently-sloping foreshores are more vulnerable to damage than those in deeper water because of wave shape changes while travelling towards the shore (see Section 5.2.2.2), when otherwise the same wave conditions at the toe of the structure apply. As a rule of thumb, the size of the stones required for stability of the armour layer is some 10 per cent larger than that in deeper water. As a guidance for the term *very shallow water* the following may be applied:  $h < 2 H_{s-toe}$  where  $h$  is the water depth in front of the structure relative to design water level (m) and  $H_{s-toe}$  is the significant wave height just in front of the toe of the structure (m). Note that deep water is defined as  $h > 3 H_{s-toe}$  (see Section 5.2.2.2):

- for side slopes of low-crested structures, see Section 5.2.2.4
- for crest and rear-side of marginally overtopped structures, see Section 5.2.2.11.

Where smaller armourstone is preferred, grouting (see Section 8.6.1) or gabions (see Section 8.6.2) may be an appropriate response and their design is also discussed in 5.2.2.7.

The design methodology is illustrated in Box 8.5 for ship-induced waves, see Section 8.3.5.2.

### Step 3: Selection and specification of the cover layer material

The design value of  $D_{n50}$  being determined (see Step 2), the median mass required  $M_{50}$  can be determined by  $M_{50} = \rho_r D_{n50}^3$  (see Equation 3.9). The appropriate grading is selected from the standard grading requirements of EN 13383:2002 (see Section 3.4.3.2). It may be



necessary to use a non-standard grading for specific cases or to fit local production (see Section 3.4.3.9). The *simple* non-standard grading approach is usually sufficient, however, for specific requirements a detailed approach may be used.

Attention should be paid to durability of the armourstone used (see Section 3.6), notably with reference to weathering processes such as freeze and thaw (see Section 3.8.6).

**Box 8.3**      *Design of a revetment cover layer against current attack*

The reader should note that design equations are sensitive to the choice of input parameters. In particular, the depth-averaged velocity should be used for Pilarczyk's and Maynard's approaches while the near-bed velocity is to be used for Escarameia and May's approach. Standard values of the other input parameters are given in Section 5.2.3.1, however, more detailed values may be relevant. When using Pilarczyk's approach, the reader should refer to:

- Section 5.2.1.3 to determine the turbulence factor  $k_t$ . At a site where fairly high but not excessive turbulence is expected, a value of  $r = 0.20$  may be used (see Section 4.3.2.5).
- Section 5.2.1.8 to determine the depth factor  $\Lambda_n$  required to determine the velocity profile factor  $k_h$ .

When using Escarameia and May's approach, the reader should refer to Section 4.3.2.5 to determine the turbulence intensity required for calculation of the turbulence coefficient  $C_T$ .

The result is expressed as an armourstone size required for stability, including a safety coefficient for Maynard's approach. The reader should note that both Pilarczyk's and Escarameia's approaches provide a median size  $D_{n50}$  that can be easily converted into  $M_{50}$  and allow selection of a standard grading (see Step 3). However, Maynard's equation provides a median sieve size  $D_{50}$  with  $D_{n50} \cong 0.84 D_{50}$  (see Section 3.4.2 for further discussion on the relation between  $D_n$  and  $D$ ).

A standard double layer thickness is  $2k_t D_{n50}$  (see Section 3.5.1 for values of the layer thickness coefficient,  $k_t$  (-)). When small armourstone is required for weak currents, it may be practical to use a thicker layer to sink a geotextile and a fascine mattress. Conversely, assuming a minimum thickness of 0.5 m is required for construction purposes, ie  $D_{n50} = 0.203$  m, the hydraulic stability for this armourstone size may be checked to confirm if sufficient.

**Step 4: Design of the filter system and sublayer**

In principle, a granular filter could be used between the subsoil and the cover layer. In practice, geotextiles are increasingly used for this purpose. The filter criteria for both granular and geotextile filters are given in Section 5.4.3.6. Three different criteria should be satisfied by the filter system:

- functional requirement, ie meeting filter rule requirements
- construction requirement, notably when placing geotextile or granular filter underwater
- durability requirement, ie sufficient resistance during construction and the structure lifetime.

The option of a full multi-layered granular filter, placed in thin layers on a slope underwater, is rarely practicable in river engineering works, except for very large structures. A composite filter, consisting of a geotextile and a granular layer is more common. Often it is appropriate to place the armour layer directly onto a geotextile (without sublayer), or onto a gravel underlayer without geotextile.

In Box 8.4, the functional requirements are discussed for the specific case of a geotextile filter. These functional requirements concern the interface stability of the base soil with the geotextile filter fabric and the filter permeability. When the cover layer is directly applied onto the geotextile filter, specific attention should be paid to ensuring it is not damaged during construction (see Section 9.7.1).



**Box 8.4** Functional requirement and design of a geotextile filter

The required properties of the geotextile depend on the subsoil. A geotextile filter is used as a substitute or complement of a granular filter(s), indices  $f$  and  $b$  are used, referring to filter and base respectively. Both the interface stability and the filter permeability should be verified (see Section 5.4.3.6 for design methods and Section 3.16 for geotextile specifications).

**Interface stability:**

The interface stability is controlled by the indicative diameter of the soil particles to be filtered,  $D_I$ , and the characteristics of the geotextile to be selected, ie the filtration opening size of the geotextile filter  $O_{90,w}$  and the minimum value of the geotextile opening size  $D_{min}$ . A widely used stability rule is given in Equation 5.278:  $D_{min} \leq O_{90,w} \leq D_I$ , where  $D_I = C D_{85,b}$  (see Equation 5.279)

**Filter permeability:**

The permeability of the filter should be verified and the criterion is expressed by the permeability rule on filtering and filtered permeability  $k_f \gg k_b$ . The reader should note that more detailed relations are given for the different types of soils to be filtered, ie for silty soils and fine sands notably (see Section 5.4.3.6 and Equation 5.276 and 5.283).

**Conclusion:** the requirement for the geotextile filter can be expressed in terms of a range of  $O_{90,w}$  and a minimum value of  $k_f = 16$  to  $25 k_b$  (m/s).

**Step 5: Design of the toe protection and any transitions**

The different options for the choice of the type of toe protection (see Section 8.2.7.3 and Section 5.2.3.3) should be studied. Different typical solutions are given in Section 8.2.7.6 and the associated transitions are also discussed. For the specific case of falling apron, please refer to Section 8.2.7.4.

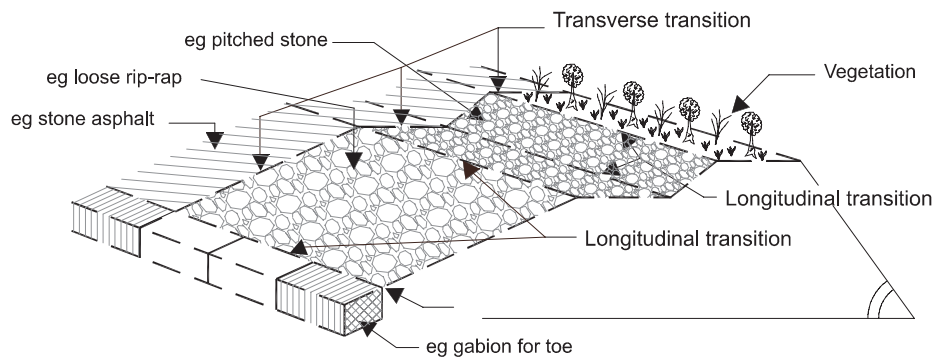
**NOTE:** Apart from designing the revetment slope and toe against currents and wave attack, in areas where ice loads can be expected, special attention should be paid to the phenomena of ice and to the measures to protect the rock structure against the forces of ice (see also Section 8.2.6.1).

**8.2.7.6****Transitions****Definitions**

In this section a brief overview is given of the requirements for transitions, including some examples. Transitions occur between different types of revetments, at the structure toe, at a berm and the crests. Transition may take place over a certain length, ie in a transition zone or at a contact zone between two systems. Two different types of transitions can be considered ie *transverse transition* and *longitudinal transition* illustrated in Figure 8.30.

For both transitions, similar construction methods are applied. However, the transition zone is often the weak point of a construction at which initial damage to the revetment occurs. Typical damage that can occur at transition zones includes:

- **washout** of stones or **uplift** of mattresses or revetment stones
- **infiltration** of filter material from one layer into the other resulting in settlement of the armour layer
- **washout of sand**, fine filter materials or clay through gaps or along structural elements such as piles which stick through the filter and top layer
- **decay** of wooden piles and planks
- **frost** damage to cement mortar.



**Figure 8.30** Transverse and longitudinal transitions

If possible, longitudinal transitions should be avoided. It is desirable that a bank slope is protected by one type of revetment from the toe to the top edge. However, this is practical for situations where the height of the bank protected is not large. For large heights, a change in the composition of the revetment is not uncommon. This is not always easy to achieve, for instance when a revetment is being extended or if different systems are adopted for the lower and upper parts of the revetment. In those cases with an impermeable upper layer the designer must carefully consider the consequences of uplift pressures. This can be done by increasing the mass of the armourstone for the armour layer.

Transverse transitions should be reinforced and the following techniques are recommended:

- **increase the thickness** of the cover layer at the transition
- **grout** rip-rap or block cover layers with bituminous grout
- **use concrete edge-strips** or board to prevent damage progressing along the bank.

Transverse transitions are particularly vulnerable in fast flowing channels, because any local irregularities will cause turbulence that can pluck out individual armour stones or lift up the edge of a mattress. Once local damage has been caused, it can rapidly escalate because the turbulence is increased and flow can get under the revetment. For this reason lateral transitions should not be placed in the bed or banks of a channel immediately downstream of a structure such as a sluice, where rapid and turbulent flow can be expected. In such situations, heavy revetments should be used in the zone of high turbulence, and the transition located where the flow regime is more tranquil.

Requirements for transitional structures can be subdivided into **functional** requirements, requirements for **constructability** and requirements for **management and maintenance** discussed here:

#### Functional requirements

The following list below is an *aide-memoire* of the functional issues to consider when dealing with a transition during the design:

- the transition zone should at least have the same **strength** and functionality as the strongest of the two joining revetments
- the **permeability** of the top layer should be the same as that of the most permeable of the two joining revetments. Preferably the permeability of the filter should not be more than that of the least permeable of the two joining filters. **Uplift pressures** should be considered for the design of the transition zone. When using different types of sub-layers, no transport of material should occur from one layer into the other layer, or from the subsoil into the filter layer

- the transition zone should at least be as **flexible** as the two joining revetments. Consequently, the local settlements will not lead to undesired damage, such as cavities. When using concrete kerbs or piles, this may not be achieved and specific attention should be paid at these potentially weak zones
- the durability of the transition should be as good as that of the two joining revetments. This may not be practical when using timber piles which have a lower life expectancy unless made of hardwood for which there may be some sustainability concerns or of treated softwood which may have some environmental concerns with respect to pollution.

Toe structures should provide protection to the revetment against scour of the riverbed, prevent sliding of the revetment, and be able to drain ground water if present. The transition should have reserve stability in the case of washout of stones, eg using a falling apron. Vertical joints along the river direction, eg with piles, should be studied in detail as there is a high risk of washout of filter and base material.

#### Requirements for constructability

The list below is compiled from project feedback on problems that may occur and which should be considered, with specific reference to excavation and grouting:

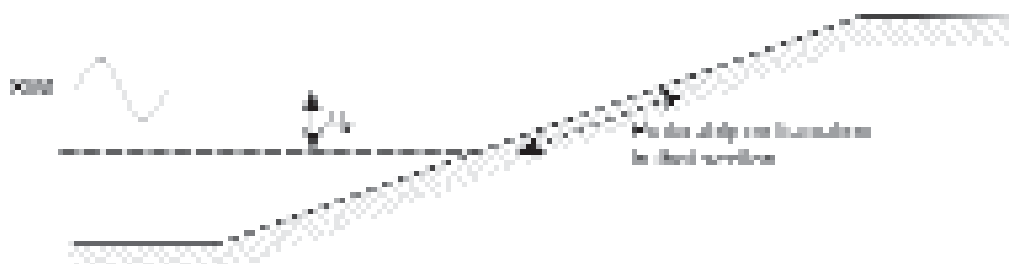
- if the edge of the revetment requires local **excavation** to allow placing, it should be ensured that good **compaction** of any backfill can be achieved
- wide and deep excavations at transitions should preferably be **avoided**. Suitable tolerances during construction are essential. If necessary excavations using machines should be supplemented by **excavations by manpower**
- **over-excavation** should be avoided and, if it occurs, the resulting void can be **replaced by gravel or similar filter/underlayer**. In particular, over-excavation adjacent to structures (eg sheet pile walls, concrete cut-offs) should be avoided as it may destabilise the structure
- **asphalt and cement grouting** (both mortar and concrete) at transition zones should be done as soon as possible after construction to avoid filling by silt, plants and undesired stones. However, grouting using mortar or concrete should be considered with care since it increases the rigidity of the transition and making it more vulnerable to damage
- **gaps** that are to be grouted by asphalt and cement grouting should have a width of at least 2 cm
- **prior to grouting asphalt**, the suitability of all parts of the transition structure should be checked. Note that some geotextiles can be adversely affected by heat.

Excavations should be executed with care. With mechanical excavation, trenches are often dug too wide and too deep, which can affect the geotechnical stability of the transition structure, for example in the case of vertical boundary elements of wood/concrete. Over-excavation will also lead to local settlements, as backfilled soil is difficult to compact.

#### Management and maintenance requirements

Structures designed and built to a reasonable standard should meet to all management and maintenance needs. However, transitions may need more maintenance than the revetment itself and :

- the number of transitions should be kept to a minimum
- transitions should not be made in the area between the design water level and a point below the design water level. For estuarine rivers, transitions should preferably not be made in the section as indicated in Figure 8.31.



**Figure 8.31** Indication of zone of severest attack (SWL = Still Water Level and  $H_s$  = design significant wave height)

### Examples of typical longitudinal transitions

This section highlights examples of transitions between two revetment types (see Figures 8.32 to 8.40). The designer may select and adapt these examples of transitions and toe to ensure the best fit with the local conditions of the project.

Figure 8.32 shows an example of a transition using grouting between different types of revetments. Note that the grouting may not be required in all of the stone work. In Figure 8.32, loose rip-rap is placed under water and asphalt mastic grout is only used at the transition with the open stone asphalt (as used in Bharaid Bazar project). Grouted stone asphalt can be used in this case provided the layer thickness is determined sufficient to account for the uplift forces. The detailed determination of uplift pressures is out of the scope of this manual but is introduced in Section 5.4.5. In most cases open stone asphalt can be used, which is preferably executed in the upper zone. The level of the berm should be selected so that the grouting can be carried out under dry conditions.



**Figure 8.32** Transition from penetrated or grouted stone to rip-rap. Asphalt grouting is preferably done above the water level (dimensions in m)

Between a concrete block revetment and rip-rap, grouting may be limited to the vicinity of the concrete kerb which provides toe support for the concrete blocks (see Figure 8.33 left). In this case, the material used for the granular filter was recycled minestone that was used as underlayer instead of sand (see Section 3.13 for recommendation on the use of alternative materials). In Figure 8.33 right, a dividing wall of wooden piles is used, often called “planking”. Sustainable use of timber resources and environmental pollution from treated softwood should be considered in this case. Note that there is no filter between the clay base and the open concrete blocks. If there is any concern about the erosion of the clay it is recommended to add a filter (granular or geotextile) underneath the concrete blocks.

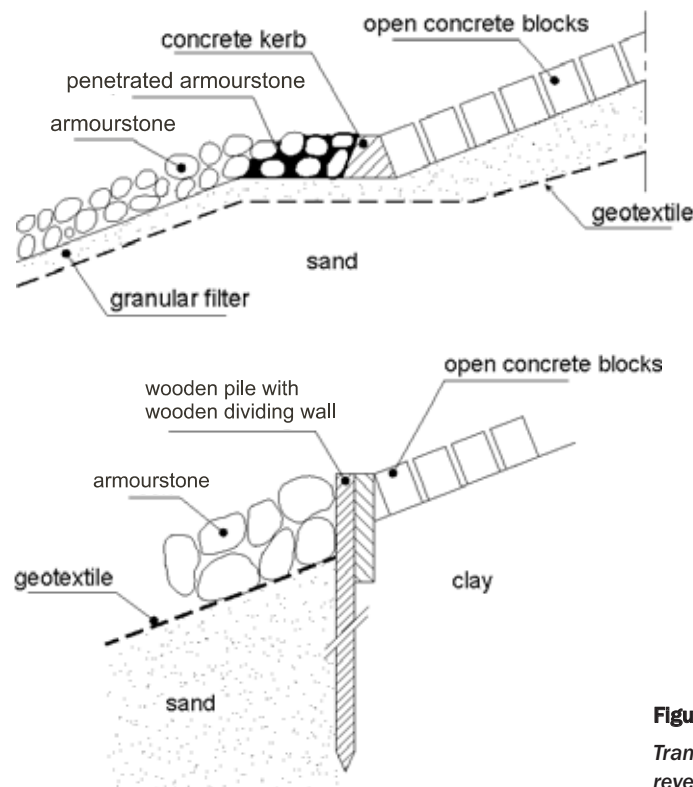


Figure 8.33

Transition from concrete block revetments to rip-rap or armourstone

#### Examples of transitions at the toe of the structure

Toe structures are relatively heavy structures as the toe needs to support the weight of the slope protection. Note that in estuarine rivers, the toe may be quite similar to those shown in Section 6.3.4.1. For limited water depths and short revetments, a lighter toe may be sufficient while a more significant toe structure may be required for heavier revetments and more aggressive environments, notably where greater scour can be expected.

Figure 8.34 presents a typical toe detail using piles. The pile length depends on the thickness of the revetment, ie the forces applied on the upper part of the pile and on the ground characteristics. When scour is expected, this may need consideration when selecting the pile length. The use of piles at the toe should be studied with reference to the various engineering constraints, such as armourstone availability, geometry restriction. When armourstone is available in abundance and if there are no geometrical constraints, a falling apron may be preferred.

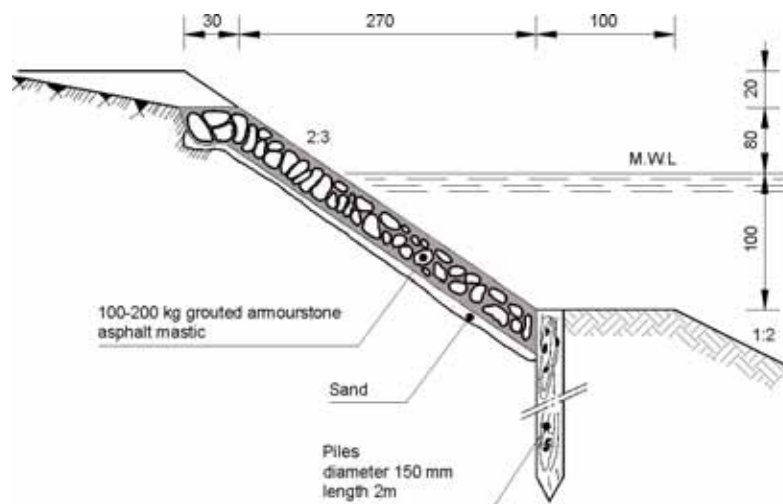
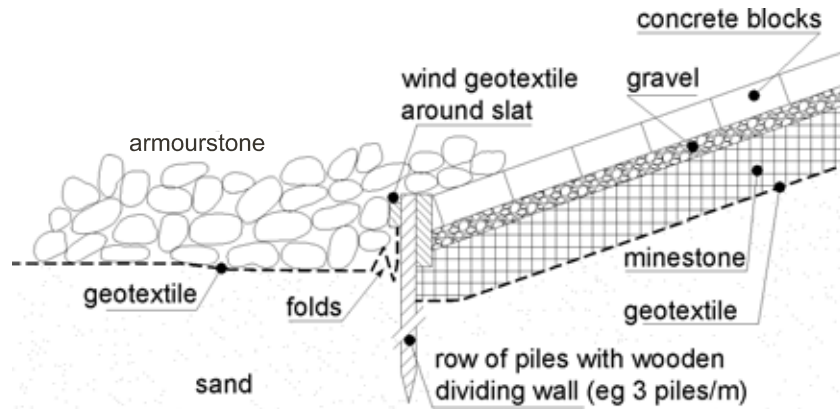


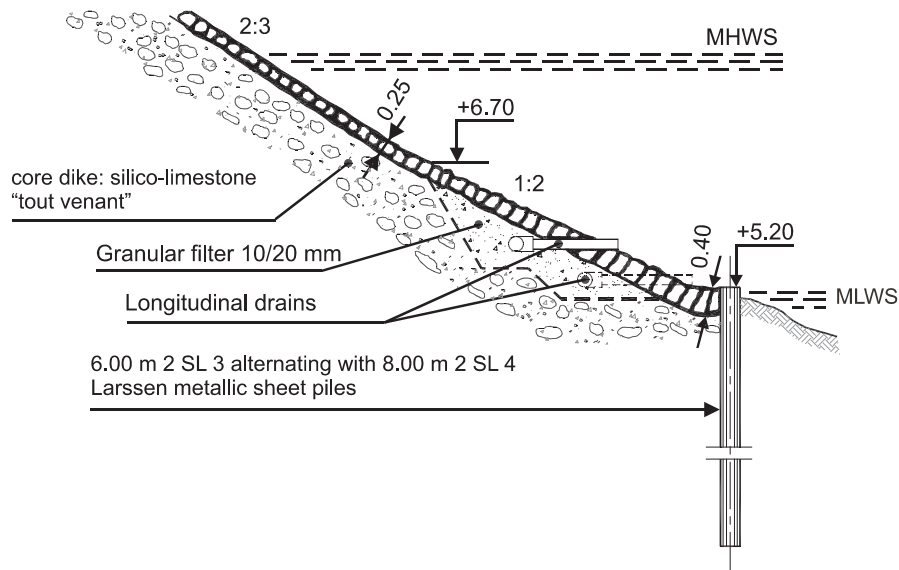
Figure 8.34 Typical toe detail using a row of piles (dimensions in cm)

Figure 8.35 presents a toe detail that combines different types of materials (armourstone and wood pile) and different functions (blocking the concrete blocks and protecting against scour). In this particular case, the armourstone at the toe, which can act as a falling apron, should be designed to prevent scour at the piles. In most cases, it will not be an economical solution to use both and it may be appropriate to determine the length of pile required or to design a proper falling apron.

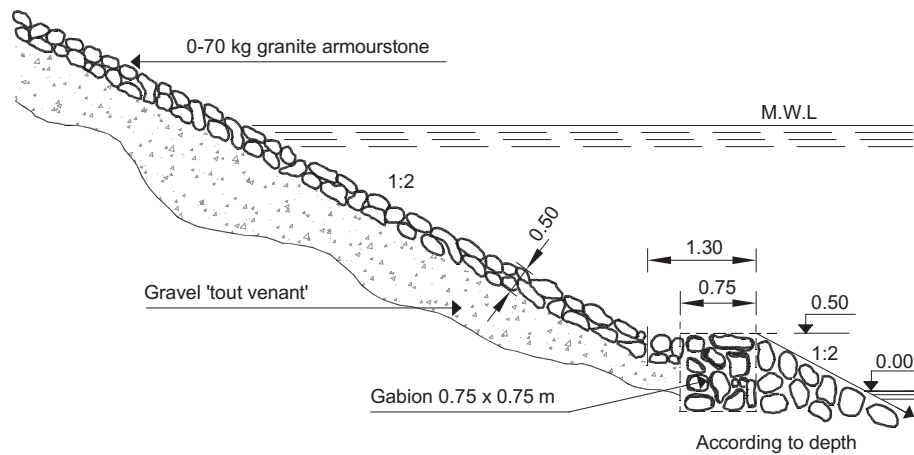


**Figure 8.35** Typical toe detail using different types of materials

Figure 8.36 presents a toe detail using a sheet pile wall. Note that the revetment in Figure 8.36 that was used in an estuarine environment displays drainage as a means of avoiding uplift pressures underneath the grouted stones. Figure 8.37 shows a typical example of the use of gabion boxes for toe stabilisation.



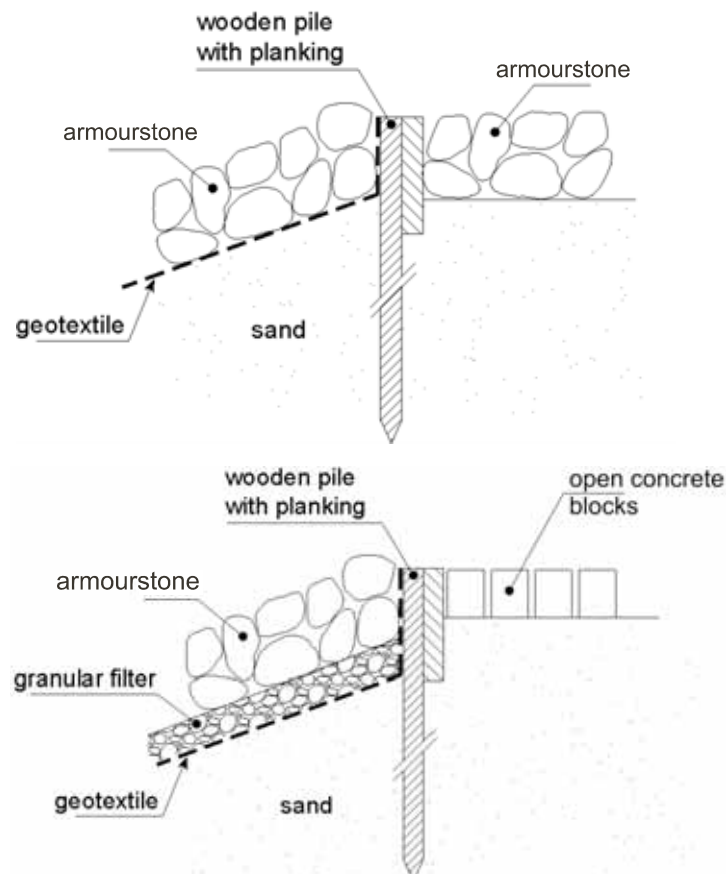
**Figure 8.36** Connection of armourstone revetment with a sheet pile wall in estuarine environment (dimensions in m)



**Figure 8.37** The use of gabion boxes as a toe for a double layer of loose stone (dimensions in m)

#### Example of details for berms

Berms are characterised by transitions from steep slopes to gentler slopes or horizontal sections and vice versa. This zone may be vulnerable to high loads and damage can occur. Figure 8.38 gives typical examples of design details for the front edge of a berm in a dike above the water level.



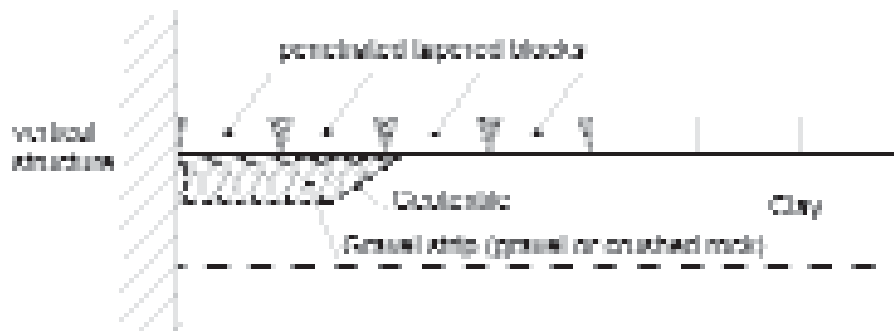
**Figure 8.38**  
Example of transitions to berm on a stone revetment

#### Example of vertical transitions

Transitions are defined in Section 8.2.7.6. Vertical transitions occur at the connection between slope protection and bed protection with a vertical structure. Typical vertical structures are a sheet pile wall (see Figure 8.36) or a concrete wall (see Figure 8.39). Specific

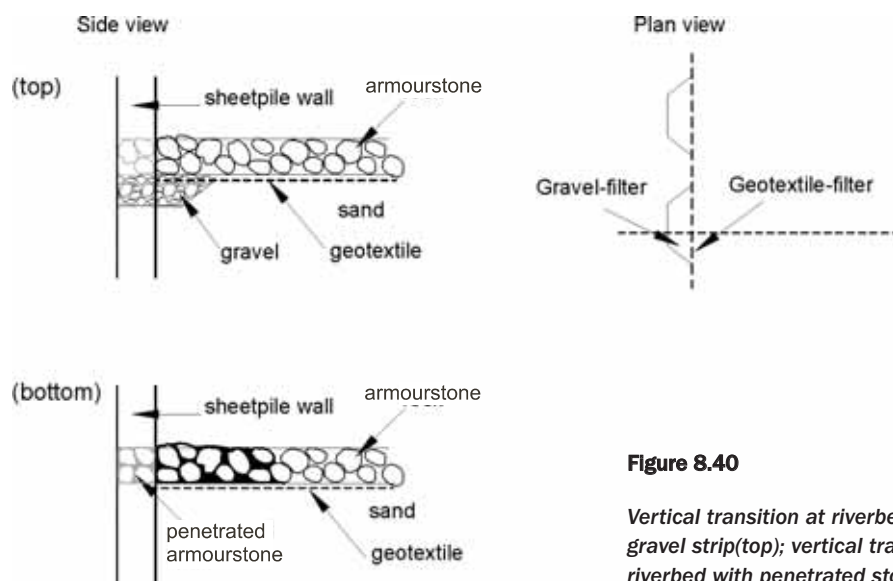


attention should be paid at this transition since washout of material through the joint near the vertical structure is hard to prevent. In addition, the stiffness of both systems are significantly different which may lead to concentration of damage. This can be solved by penetrating a strip of about 1 m of the armour layer with asphalt or grout. A granular filter will be required in cases where the armour layer is positioned immediately on sand or clay. Figure 8.39 gives an example of such a transition, which can be applied for abutments of bridges. The gravel strip is important for construction purposes as it provides a firm surface to lay the concrete blocks and ensure a clean connection close to the wall. Note an outlet should be provided to ensure pressure relief.



**Figure 8.39** Penetrated armour and gravel strip near vertical transition

Figure 8.40 presents examples of vertical transitions between a bed protection and a vertical structure by means of a gravel strip and penetrated stone. The geotextile is not present underneath the gravel as this will be difficult to construct. The plan view on the right hand side shows how in the case of the granular filter, the filter extends into the pans in the sheet pile wall profile.



**Figure 8.40**

*Vertical transition at riverbed with gravel strip (top); vertical transition at riverbed with penetrated stone (bottom)*

## 8.2.8 Materials issues that influence design

### 8.2.8.1 Materials availability

Armourstone is a widely used material for river training structures, most commonly as an armour layer in revetment systems. Crushed rock can be used as an underlayer or filter layer, and stones that are too small for armourstone or rip-rap can be used effectively in gabions and gabion mattresses. Armourstone is used in river works for three main reasons:



- it is a durable engineering material, ideally suited to river training works
- it often provides the most economically viable solution, especially if available from a source local to the site
- it is more environmentally acceptable compared with other materials such as concrete, wood or steel.

Local circumstances will determine whether armourstone is the most suitable material (see Section 3.1). Other materials or systems such as concrete blocks, sand cement blocks, gabions, concrete block mattresses, open stone asphalt and even steel sheet piles may provide acceptable solutions in certain circumstances.

The decision to use local or imported armourstone depends not only on financial considerations such as cost (or foreign currency requirements), but also on the required density, grading, durability, construction programme, work methods and overall quantities needed. Armourstone and gravel can be obtained from marine and riverine sources (although specific environmental regulation generally applies), as well as from quarries. In deltaic countries or regions deprived of good quality stone such as the Netherlands, natural sources are rare and importation of armourstone is essential if it is to be used on major works. For example, the Eastern Scheldt storm surge barrier required stone coming from countries as far as Finland. In most cases, the size of the project does not warrant such remote sources of supply to be considered.

If the ideal armourstone of the right grading and quality is only available at high financial cost or with significant environmental impact, then it may be possible to amend the design to suit readily available material sources. This can be achieved for example by taking into account the effect of weathering and degradation for poorer quality materials (see Section 3.6) or by using smaller armourstone in gabions or in combination with grout to achieve the same degree of protection as a revetment using large stones.

### **8.2.8.2 Materials supply and transport**

Supply of materials can be by land-based or waterborne transport (see Section 9.4). The appropriate transportation methods will largely be driven by logistics and economics. However, environmental factors should also be considered in detail. For example, the environmental impact of noise, dust and disturbance to local residents, as a consequence of transporting armourstone by road, may tip the balance in favour of alternative means such as barges on the river.

Important practical constraints of land-based material supply can include the width and bearing capacity of roads as well as traffic density, and the presence of urban developments between the source of supply and the construction site. Access along the side of the river is an attractive option if practicable in terms of the space available for the track and the load capacity of access tracks. Rivers with flood defences often have access tracks for inspection and maintenance, although these may not accommodate heavy construction traffic without upgrading.

Ideally the river itself should form the transportation route, for major navigable rivers this is often the best option. However, for smaller rivers, seasonal restrictions related to the depth of flow or environmental factors may make river transport impractical. These factors should be considered when selecting the potential rock source.

It is important to investigate all factors when considering suitable sources of armourstone. Transporting armourstone by rail would be ideal environmentally, but this may induce additional handling of the armourstone, ie from quarry to railhead, transfer to road for the last part of the journey, and then transfer to stockpile at the site.

## 8.2.9 Construction issues that influence design

### 8.2.9.1 Approaches to construction

As part of the design process it is vital to consider how the works will be constructed. In particular, the design may be fundamentally affected if the works are to be constructed underwater rather than in the dry. Underwater construction presents particular difficulties for placing any form of underlayer, including geotextile filters (see Section 9.7) and for the control of construction tolerances (see Section 9.8). While construction in the dry allows fairly tight control over the dimensions of excavations, and the location and thicknesses of materials placed, the same is not true for underwater construction. Furthermore, checking the quality of construction is far more difficult underwater.

In some situations, it may be effective to consider temporary works, such as cofferdams to allow construction in the dry. In any situation, temporary works design should allow for the possibility of flood flows.

For the above reasons, if there are possibilities for constructing works in the dry, they should be fully explored as part of the design development. Options include:

- **constructing the works on dry land** adjacent to the river and then diverting the river. This option is particularly attractive if the works can be constructed in a meander loop or bend in the river
- **temporary diversion** of the river allows construction to take place in the dry riverbed
- for small streams, **isolate the reach** of river with low dams and pump the dry weather flow round the works
- for works that span the river, such as a pipe crossing, **constructing the works in two halves** using a cofferdam to isolate each half in turn, with the river flow passing through the other half
- **constructing the works during a period of minimum flow** when much of the works will be above water level.

### 8.2.9.2 Construction situations

For underlayers, geotextiles and mattresses, the largest loadings usually occur during construction. This is due to the weight of the component itself, eg in the case of a mattress placed on a relatively steep (1:3 or steeper) slope or due to impact forces caused by dumping of stones. In this respect, stones dumped directly on to a geotextile may cause damage to the fabric. So it is essential to consult the manufacturer of the geotextile with regard to acceptable construction practices. In general, dumping of stone larger than grading 10-60 kg is not advised (see Section 9.7.1.2). If this is unavoidable, another method of placement or an intermediate granular layer should be applied as an alternative. Care should also be taken to ensure an appropriate geotextile is specified that can resist construction loads, see Section 3.16.

The option of a fascine mattress may be suitable to overcome the problem of placing the underlayer and/or a geotextile filter. Alternatively, some geotextile filters are available which are impregnated with sand or sand-asphalt that makes them easier to place underwater.

For constructing revetment systems underwater, armourstone combined with a mattress that is floated to location and then sunk by means of ballasting the mattress, can be used (see Section 9.7.1.2).

Waves occurring during the placing process can make accurate placing of geotextile filters and coarse stone or gravel underlayer difficult. Currents are helpful during the sinking operation if used correctly; this is called *sinking on current* (see Section 9.7). Even if placed

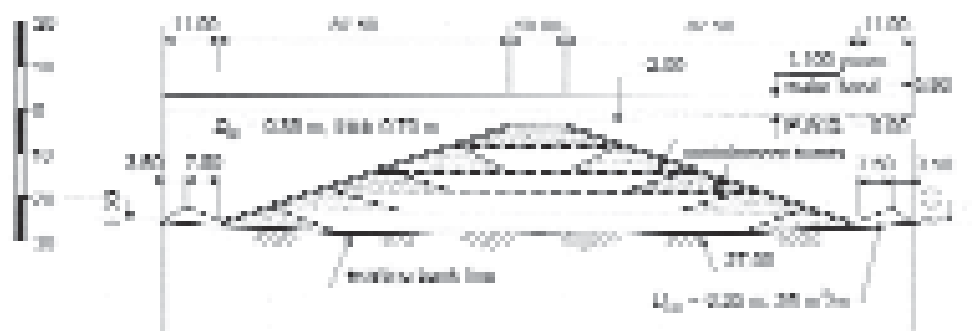
accurately the wave forces may dislodge them before the armourstone layer can be placed. This problem can be overcome by avoiding periods when such conditions might occur.

Plans should be made where sediment transport is to be expected. A revetment is normally placed in layers, for example geotextile, a gravel or coarse stone underlayer, and armourstone cover layer. Sediment can be deposited on one layer before the next one is laid, particularly if high flows persist between the two operations. This can leave an unwanted layer of fine particles in the revetment, which would be difficult to remove, and which may compromise the performance of the revetment by sealing the filter layer. There are three options to prevent this occurring:

- try to construct the protection system in the shortest possible time, eg by applying a geotextile with fascines rather than a granular filter or a geotextile only and minimise the distance between advancing fronts of the different layers (to ensure unprotected interim layers are kept to a minimum)
- apply a pre-fabricated mattress that is placed in position using a floating drum or a floating crane
- separate the slope to be protected from the river by means of a cofferdam or construct the protection in a trench dredged in a sandbank or behind the riverbank.

For river training structures waterborne plant is required in many projects and land-based plant can only replace a waterborne plant for a part of the work. This may, for example, require a berm to be incorporated in the design of the riverbank cross-section to allow access by land-based plant. Such a berm can also be used for maintenance purposes.

When a spur-dike is to be constructed in flowing water – even if constructed outside the flood season – it may be necessary to place a bed protection mattress prior to the start of construction, and to construct the body of the spur from quarried rock. This may be a low durability material due to the limited time of exposure, such as sand asphalt or sand cement blocks instead of earth. Effectively, the spur cannot be constructed from earth in flowing water, but to use armourstone to construct the whole spur would be too expensive. Thus a compromise is to have a core formed of material that can resist erosion for a brief period in the conditions experienced during construction, while the armour layer provides the erosion resistance for design conditions. On top of this rather low quality body the protective revetment or rip-rap layer can then be placed in the usual manner (see Chapter 9), although sediment deposition may complicate this process. For larger spur-dikes, guide bunds and also for slope protection constructed in flowing water, a system of containment bunds may suffice to allow the placing of successive layers of earth, sand or silt behind (in the case of bank protection) or in between (in the case of spur-dikes). Figure 8.41 illustrates this process for a spur-dike. The spur is built up in layers, each layer being formed from fill material placed between armourstone containment bunds. The resulting structure has an armoured outer face and a core of finer material. The cross-section of the existing bed at the end of the dike or of the existing bank closer to the root of the dike is located where “existing bank line” is shown on Figure 8.41.



**Figure 8.41** Cross-section of a spur-dike constructed by means of containment bunds (dimensions in m)

### 8.2.10 Maintenance issues that influence design

Chapter 10 examines maintenance in detail. However, it is important to consider in the early stages of design how and when maintenance will take place, in particular with reference to the flood season. Maintenance should also be considered when selecting the appropriate type of cross-section for river training structures. It is also vital to determine who will be responsible and what equipment will be available for maintenance activities. Issues to consider in the various design stages in respect of river training works include:

- **durability** of the protection system, including the accepted reduction in stone size and acceptable damage during service, and the capacity of the owner to maintain the structure
- **size of stones** in view of manual or equipment handling
- **availability of local material** for repair and possibility to create stockpile of material for maintenance purposes
- **provision of a berm** to allow maintenance of the lower part of the revetment
- **wide crest**, eg of spur-dike, to allow access for large trucks.

An effectively designed structure should withstand the loads imposed by the river, but other causes of damage should also be considered in the design. Table 8.3, adapted from PIANC (1987b), gives an *aide-memoire* of design measures which can help to overcome or address causes of damage. The aim of these measures is to avoid degradation or to make maintenance easier.

**Table 8.3** Causes of damage to bank protection (after PIANC, 1987b)

Feature	Cause	Effect	Design measure
Abrasion	Ice floes and debris floating in the waterway	<ul style="list-style-type: none"> <li>● impact near waterline</li> <li>● displacement of armourstones</li> <li>● puncturing of membranes</li> </ul>	<ul style="list-style-type: none"> <li>● design for resistance to impact</li> <li>● allow for easy repair</li> <li>● deflect water flow, eg by groynes</li> </ul>
	Abrasive sediment in high velocity flow, such as sand, gravels, cobbles, boulders	Grinding action at toe wearing through exposed fabrics, gabion baskets	<ul style="list-style-type: none"> <li>● incorporate a sacrificial layer of armour</li> <li>● avoid use of gabions in cases of extreme abrasion</li> </ul>
	Pack ice	Shearing force on cover layer due to ice-sheets riding up the revetment	Provide cover layer able to withstand load, design procedures are available IAHR (1980) and see Section 5.2.4)
Biological	Livestock	Grazing and trampling leading to destruction of vegetative protection	<ul style="list-style-type: none"> <li>● fence-off revetment</li> <li>● use non-degradable reinforcement to soil</li> </ul>
	Vermin	Burrowing into bank Gnawing through geotextiles or cables	Pest control Provide an impenetrable top layer
	Plant growth	Roots alter geometry of top layer	Vegetation control if necessary
	Seaweed and algae	Surface damage to asphaltic top layers	Bituminous sprays
	Microbes	Attack some natural fibres	Use resistant materials unless degradation is a specific requirement
Chemical	Oils and hydro-carbons	Attack bituminous systems	Avoid contact
	Sulphates	Attack concrete	Use sulphate resisting cement
	Other aggressive salts	Corrosion of steel wire, cables, connections	<ul style="list-style-type: none"> <li>● protect by galvanising and/or pvc coating</li> <li>● use heavier wires and cables, or suitable stainless steel wires and cables</li> </ul>

**Table 8.3** Causes of damage to bank protection (after PIANC, 1987b) (contd)

Temperature	Frost heave	Formation of ice crystals in subsoil leading to change in geometry of top layer	Use non-capillary soils in frost susceptible zones
	Extremely low temperatures	Brittle behaviour of geotextiles	Check working temperature range of material.
	High temperatures	<ul style="list-style-type: none"> <li>• creep of geotextiles</li> <li>• flow of bituminous materials down slope</li> <li>• accelerated weathering of rock</li> </ul>	Check working temperature range of material and expected degradation.
	Freeze/thaw	Spalling of rock or concrete armour	<ul style="list-style-type: none"> <li>• use appropriate quality rock, durable top layer</li> <li>• allow for some stone degradation in the design</li> </ul>
Human action	Vandalism or theft	<ul style="list-style-type: none"> <li>• cutting and removal of geotextiles</li> <li>• cutting of cables and wires in gabions</li> <li>• removal of rip-rap or loose concrete blocks</li> <li>• fire damage</li> <li>• more common in urban areas and poor rural areas</li> </ul>	<ul style="list-style-type: none"> <li>• provide protective cover to fabric</li> <li>• use heavy-weight top layer</li> <li>• consult with local representatives prior to construction to determine scale of problem and to determine counter-measures</li> </ul>
	Washing places	<ul style="list-style-type: none"> <li>• fill material between stones gets washed out</li> <li>• stones are undermined</li> </ul>	<ul style="list-style-type: none"> <li>• special interlocking stones or fixing of stones with asphalt</li> <li>• construct custom-designed washing places</li> </ul>
	Mooring of small craft to poles in revetment	Stones are ripped out of revetment	Provision of special mooring devices
Traffic	Ship/bank collision	Local destruction of revetment	Allow for easy repair or if failure is unacceptable then design to resist impact or incorporate a fendering structure
	Dragging anchors	Local abrasion of top layer and possibly subsoil	Provide stronger top layer in areas where ships are likely to anchor
	Overdredging	Accelerates toe scour	Better control over dredging operations
Ultra-violet Light	Sunlight	Loss of strength and degradation of plastics or geotextiles	<ul style="list-style-type: none"> <li>• use a stabilised material</li> <li>• limit exposure to sunlight during construction and in use</li> </ul>

### 8.2.11 Repair and upgrading

Section 10.5 gives a general overview of the aspects related to repair and upgrading of river (and canal) structures.

Prior to studying the solution for repair or upgrade of the structure, the reasons for degradation should be identified (see Table 8.3). For river structures the main sources of degradation are :

- frost effects and degradation of stones
- excess of hydraulic loads and loss of stones
- toe erosion, for example due to general bed erosion.

The methods and issues to address for the design of repair works are similar to those to consider for new structures. However, specific attention should be paid to the following:

- correct analysis of the **causes of degradation**
- **transitions** between the repaired zone and the existing ones
- the **evolution of hydraulic loads and the sizing of armourstone**, when compared to the old existing structure, should be verified.

If the structure is not heavily damaged but no longer able to resist the loads, a simple solution may sometimes consist of grouting with concrete or bitumen.

## 8.3 NAVIGATION AND WATER CONVEYANCE CANALS

### 8.3.1 Introduction

Navigation and water supply canals are man-made structures designed for shipping and/or conveyance of water. These channels have much less variation in flow velocity and water level than rivers and streams. For this reason, canals are generally subjected to smaller hydraulic loadings than natural rivers and the design of rock structures reflects this. However, the effect of ship-induced hydraulic loads in navigation canals is specific to this type of structure and should be carefully studied (see also guidance from BAW (2005)). These loads can be severe and may require substantial works to prevent local erosion of canal banks, bed or toe.

In navigation canals, armourstone is likely to be used as a revetment system as it can be a low-cost alternative to concrete. Interlinked concrete blocks or mattresses can provide an effective means of protecting canal banks without having to empty the canal.

**NOTE:** Design guidance for rock structures in navigation and water conveyance canals is discussed in this section and may differ or be additional to that already discussed in Section 8.2 on river structures. The reader should also consult Section 8.2.

### 8.3.2 Types of structures and functions

Armourstone is used in navigation and water conveyance canals as erosion protection to the banks and the bed of the channel. It may be used over extensive lengths of the canal or locally where hydraulic loads are more severe, for example in a ship mooring area, or downstream of a sluice in an irrigation canal. Armourstone revetments on canal banks can also help to stabilise the bank to decrease the risk of slope slips or slumping.

Reduction of water loss or seepage from canals is also an important consideration and often addressed using a water-retaining lining, usually concrete, clay or a synthetic liner. Armourstone cannot provide this function but may be used to protect the clay or synthetic liner from damage induced by water action or other phenomena such as weathering or vandalism.

The requirements for different types of canals are described in Sections 8.3.2.1 and 8.3.2.2.

#### 8.3.2.1 Navigation canals

Armourstone protection in navigation canals is designed to prevent erosion of the bank and the canal bed, primarily due to ship-induced water movement. Although wind waves can play a role in wide and deep navigation canals, they are often of minor importance compared to waves, currents and water level variations induced by ships (see Section 4.3).

Low current velocities can occur as a consequence of filling or emptying of navigation lock chambers at the end of a canal (although high velocities may exist in the vicinity of the locks). Tidal movement in a navigation canal will not only induce currents but will also vary water levels. The latter has an impact on the extent of exposure zone to ship-induced water movements. Flow currents can also be experienced if the canal has a drainage function, for example by accepting water during storms or floods from a motorway or urban area and transporting it to a point where it can be discharged into a river.

Bed protection may not be required in navigation canals apart from some protection near the toe of the slopes in shallow canals. More extensive areas of bed protection may be required:

- at any location where ship manoeuvres may induce erosion due to propeller thrust
- near the inlet or outlet of lock chamber filling/emptying culverts
- to protect cables or pipelines that cross under the canal bed.

Bed protection in navigation canals is not favoured because it constrains anchoring. Moreover, if anchoring occurs, the bed protection works may be damaged unless intentionally constructed to resist anchor damage.

### 8.3.2.2 **Water conveyance canals**

Water conveyance canals are used for irrigation, drainage, domestic or industrial water supply purposes and as part of hydropower projects. Two or more of these functions can be combined, or combined with navigation, for example Ismailya Canal (Egypt) for water supply to Ismailya and also irrigation and navigation, Noordzeekanaal (Netherlands) for navigation, drainage and irrigation, Gloucester and Sharpness canal (United Kingdom), etc.

The conveyance of water through a canal results in flow currents that can erode the bed and banks. However, many of these canals have flat slopes, ie low gradients, and flow velocities are relatively low, typically between 0.5 and 1.0 m/s. The requirement for bank and bed protection is confined to local areas in the vicinity of structures, such as sluices and drop-structures or at sharp bends.

Local erosion protection in irrigation and drainage channels is often provided in the form of **pitched stone**, see Section 8.1.3.7.

Where the topography dictates that canals or drains have a steep slope the whole channel may require lining to prevent erosion. Concrete is the most commonly used material for lining as it provides a degree of water-tightness as well as protecting the bed and banks. The same effect can be achieved with stone pitching placed over a lining membrane, this can be an expensive option in terms of manpower.

Hydropower requires a water conveyance canal with horizontal alignment and a hydraulically smooth profile. This configuration minimises the head losses due to friction and therefore lining of such canals with armourstone is uncommon.

### 8.3.3 **Plan layout and overall concept**

The design of navigation and water conveyance canals is not within the scope of this manual, which only covers armourstone protection works within those channels. Any design considerations in this respect are only briefly mentioned. The planning and overall concept selection is based upon the principles discussed in Chapter 2. Physical boundary conditions that apply are discussed in Sections 4.3.2 (currents) and 4.3.4 (ship-induced currents and waves). For specific design methods of the bank protection relevant to navigation canals refer to PIANC (1987a) and PIANC (1987b).



For all canal works, the design of armourstone protection should consider relevant environmental, commercial and social constraints (see Chapter 2). This is essential if the works are to be constructed while the canal is in operation. Some structure-specific aspects are listed below:

- **navigation canal:** The most important factor determining the design of works in navigable canals is a full understanding of the shipping traffic that determines the hydraulic loads. Also, the operational requirements for lock structures may be important as this would result in the need to mitigate turbulent flow and local scour
- **irrigation or water supply canal:** The key considerations to determine the appropriateness of armourstone as an erosion protection material are the flow velocity in the channel and the need to reduce seepage losses.
- **hydropower canal:** Armourstone is unlikely to be a suitable option for lining hydropower canals unless head loss, friction slope and seepage losses are not critical considerations.

### 8.3.4 Cross-section design

#### 8.3.4.1 General

During the design, a cross-section that is representative of a certain stretch of waterway should be developed from the different project and environment constraints. Transitions, notably with other hydraulic structures (eg lock or quay wall) need specific attention and possibly separate design. The issues mentioned on plan layout for river structures in Section 8.2.5 should be considered although it is often much simpler for a canal.

The following aspects related to the cross-section should be discussed:

- design parameters for slope and bed protection (see Section 4.3.1)
- critical hydrodynamic loads (see Section 4.3.2 and 4.3.3)
- material availability and supply (see Section 8.2.8 and Chapter 3)
- construction considerations (see Section 8.3.6.1 and Chapter 9)
- maintenance considerations (see Section 8.3.6.2 and Chapter 10).

#### 8.3.4.2 Navigation canals

The design of a representative cross-section of a new navigation canal should start with:

- selection of type and maximum size, eg dimensions and geometry, of ships that are expected to use the canal
- navigation behaviour of ships, eg position in canal, maximum speed
- assumed traffic intensity. The traffic intensity determines the selection of a single lane, double lanes, ie passing and overtaking, or three and more parallel lanes for main navigation canals. In large canals, separate lanes are reserved for recreation vessels.

#### Main design parameters

The main design parameters include:

- the shape of the cross-section, the minimum width at bed level, the width at the minimum water level, the side slopes of the canal, the height of freeboard, and the minimum under keel clearance required
- the hydraulic roughness of the protection layer (see Section 4.3.2.3)



- flow velocities and wave heights induced by ships and wind
- water level variations caused by wind set-up, drainage discharge and by ship lock operations
- permeability and seepage
- radii of bends and possible local widening
- any dimensions of berms
- space for an inspection road.

For navigation canals, the basic shape of the cross-section is a trapezium. It is determined by the navigation conditions, such as the intensity and the maximum size of standard ships: maximum draught, width, length and engine power.

In large canals, the minimum width at the water surface should be determined by the separation of sea-going vessels, inland navigation and recreation traffic. *Freeboard* (ie the distance between the design water level and the top of the canal bank) should allow for wave run-up, settlement of the crest of the bank and extreme high water levels. A rectangular cross-section is selected if space is insufficient for a trapezoidal cross-section and armourstone is not appropriate in this situation.

#### Critical hydrodynamic loads

Different situations are to be considered as a function of the canal size :

- in **small canals**, the critical hydrodynamic loads are induced by a single ship sailing in the canal axis. Often the traffic intensity is low
- in **medium-sized canals**, the critical traffic situation can be a single ship sailing eccentrically in the canal cross-section or overtaking ships
- in **large canals**, the critical traffic situation can be a complicated combination of various ships, in both number and size.

Each of these situations should be combined with wind set-up or set-down, maximum wind wave heights translation waves (see Section 4.3.3.3), waves due to ship lock operations and drainage inflow or outflow but these are normally less important than ship-induced waves and currents. These loads have a complicated frequency distribution.

The maximum design flow velocity for a bank protection should be a combination of the maximum:

- return flow velocity (see Section 4.3.4.1)
- flow velocity of a translation wave (see Section 4.3.4.1 and 4.3.4.2).

For a bed protection the maximum design flow velocity should be a combination of the maximum:

- return flow velocity under a ship (see Section 4.3.4.1)
- flow velocity near the bed in the propeller jet (see Section 4.3.4.3)
- flow velocity in a translation wave (see Sections 4.3.4.1 and 4.3.4.2).

The maximum wave height should be the maximum of the following waves:

- wind waves (see Section 4.2.4.6)
- stern waves and sometimes also the bow wave (see Section 4.3.4.1)
- secondary ship waves (see Section 4.3.4.2).

The procedure becomes more complicated if the critical hydrodynamic load is the result of various ships, for example passing or overtaking.

In addition, seismic activity, ice formation and loads due to ice sheets should be taken into account as outlined in Section 5.2.4 and Section 4.5 (see also Section 8.2.6.1). The geotechnical boundary conditions are important especially if settlements and slides can occur. For a detailed description of these phenomena refer to Section 5.4.

### 8.3.4.3 **Water conveyance canals**

#### **Main design parameters**

Main design parameters for water conveyance canals are similar to those for navigation canals, although ship-induced loadings do not apply. These should include:

- the shape of the canal cross-section, ie the side slopes of the canal
- the height of the freeboard
- the hydraulic roughness of the protection layer
- flow velocities, wave heights and ice loads
- permeability and seepage
- radii of bends and possible local widening
- any dimensions of berms
- inspection roads.

#### **Critical hydrodynamic loads**

Flow velocities in water conveyance canals are often stable and can be accurately defined. In general, wind waves and wind set-up are of minor importance and affect only the height of the freeboard.

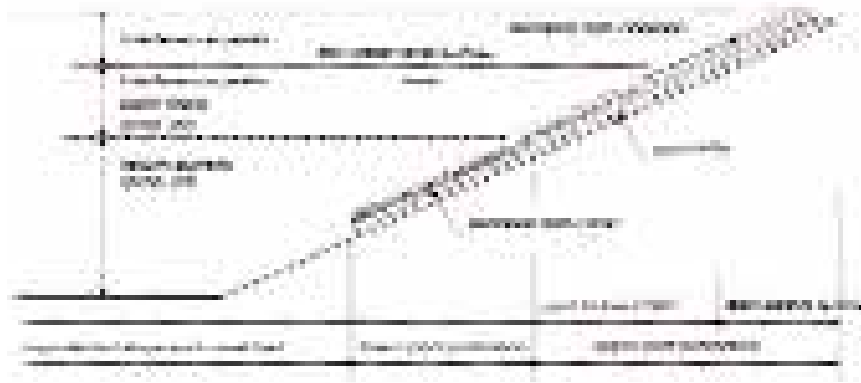
A critical factor in the design of water conveyance canals may be the speed at which the water level falls. Emergency shut-down or a breach in the canal bank can lead to rapid lowering of the water level. This can destabilise the banks, causing collapse and is a risk that should be considered as part of the design of armourstone revetments.

The selected armourstone of the protection layer should be stable for the maximum flow velocity, including a safety factor. A granular filter or a geotextile filter is required depending on the armourstone size and the characteristics of the subsoil. Much of what has been said in Section 8.2.6 on structure-specific design aspects of river training structures is also valid for slope and bed protection of canals. The primary differences are hydraulic loads, ie in navigation canals, and the fact that protection in navigation canals is normally limited to a revetment layer on the slope in the zone of current or wave attack.

### 8.3.5 **Structural details**

#### 8.3.5.1 **General**

A typical zoning for slope protection in navigation canals using dumped armourstone is shown in Figure 8.42. This zoning highlights that each ship-induced load has a different action for each specific part of the slope. Note that a bed protection is sometimes required as discussed in Section 8.3.2.1.



**Figure 8.42** Typical solutions for slope protection works in navigation canals - zoning of slope protection

Therefore, the slope protection should be designed for:

- zone of the **return current** (see Section 4.3.4.1) and **propeller jet** (see Section 4.3.4.3), if applicable
- zone of **stern wave** (see Section 4.3.4.1) and interference peaks (see Section 4.3.4.2) and propeller jet (see Section 4.3.4.3), if applicable
- zone of **interference peaks** (see Section 4.3.4.2) .

The reader should refer to Section 5.2.3.1 for stability against currents and Section 5.2.2 for stability against waves (especially 5.2.2.2, 5.2.2.7 for composite systems, 5.2.2.8 for composite slopes). When designing bed protection in all canals and slope protection in water conveyance canals, the steps are similar to those presented in Section 8.2.6.1, although toe stability is not critical in water conveyance canals. The main difference in the design of slope protection for navigation canals is consideration of ship-induced loads (see Sections 4.3.4, 5.2.2.2 and 5.2.3.1).

The currents in a shipping canal do not normally dictate the dimensions, ie layer thickness and armourstone grading, of the cover layer, except locally in the case of currents caused by propeller thrusters.

For the design of a cover layer against currents reference is made to Section 8.2.7.5.

Without further calculations, it is generally assumed as a starting point in design that the filter layer under the cover layer in the zones of the interference peaks will also act as the protection layer in the zone of the return currents, as illustrated in Figure 8.42. This should be checked for the design loads for any particular case.

### 8.3.5.2 Calculation of ship-induced hydraulic loads

Assuming that only the ship-induced loads are present in this specific case, the designer should calculate values for the following hydraulic loads:

- **depression** (see Section 4.3.4.1) in water level near the slope during passage of ship(s)
- **return current** (see Section 4.3.4.1) during passage of ship(s)
- **transverse stern wave** (see Section 4.3.4.1), ie wave height, average head difference, maximum head difference and maximum current velocity
- **secondary ship waves** (see Section 4.3.4.2)

- **current velocities** due to propeller thrust caused by manoeuvring and sailing ships, which is vital for bed protection (see Section 4.3.4.3).

The design of cover layers and filters is only given here because it differs from the calculations presented in Section 8.2.6.

As highlighted in Section 4.3.4 the computer program DIPRO (2002) enables designers to determine the slope protection of navigation canals for ship-induced loads. It is essential that designers perform some of the calculations by hand to determine the relative importance of different parameter values and to be able to select the correct hydraulic loading from a range of calculations for different scenarios. However, a typical procedure to determine the slope protection as a response to ship-induced loads is given below and illustrated in Box 8.5.

**Step 0:** Gathering data on the canal geometry and ship to consider. In some situations, it may be necessary to consider different design ships (see example in Table 8.4).

**Step 1:** Prediction of the maximum sailing speed,  $V_L$  (m/s), which can be calculated using the Equations 4.168 to 4.170.

**Step 2:** Prediction of the actual sailing speed,  $V_s$  (m/s), as provided by either Equation 4.171 or 4.172; for a loaded vessel the value of  $V_s$  corresponds to 75 per cent of the limit speed,  $V_L$  (m/s).

**Step 3:** Calculation of mean water level depression,  $\Delta h$  (m), and return current velocity,  $U_r$  (m/s), with Equations 4.173 and 4.174.

**Step 4:** Calculation of loads on slopes: front wave height  $\Delta h_f$  (m) and stern wave height  $z_{max}$  (m). The front wave height  $\Delta h_f$  (m) is determined using Equation 4.177 and the stern wave height  $z_{max}$  is determined with Equations 4.179. Secondary waves are important for the calculation of the cover layer in the upper zones of the canal slopes, determined using Equations 4.184 to 4.186.

**NOTE:** The extreme values of depression,  $\Delta \hat{h}$  (m), and return current velocity,  $\hat{U}_r$  (m/s), which are used to determine the front wave height and the stern wave height, can differ from the mean values of these parameters. This is the case when the vessel is not in the canal axis; the values of these parameters have to be calculated with Equations 4.175 and 4.176. In this respect, a larger distance,  $y$  (m), from the canal axis implies less under keel clearance, which will be problematic for shippers.

**Step 5:** Calculation of velocity induced by propeller jet,  $U_p$  (m/s), with Equations 4.187 to 4.190.

**Box 8.5** Example of typical results from a calculation procedure for slope protection due to ship-induced waves

The data for the ship and navigation canal, needed for the calculations, are summarised in Table 8.4

**Table 8.4** Basic characteristics of canal and design ships

Ship's characteristics	Design Ship A	Design Ship B
Length, $L_s$	153 m	80 m
Width, $B_s$	22.8 m	9.5 m
Draught, $T_s$	3.3 m	2.5 m
Installed power, $P$	2000 kW	200 kW
Canal characteristics	Value	
Overall wet canal profile, $A_c$	832 m <sup>2</sup>	
Side slope of canal	1:3 (cot $\alpha = 3$ )	
Depth of canal, $h$	8 m	
Width of the canal at the water surface, $b_w$	128 m	
Width of canal bed, $b_b$	80 m	

Table 8.5 shows the design parameters determined from basic data provided in Table 8.4.

**Table 8.5** Design parameters determined with data from Table 8.4

Symbol	Description of parameter	Values for different ships			
		Ship A		Ship B	
$A_c$	Overall wet canal profile	832 m <sup>2</sup>			
$\alpha$	Side slope of canal	1:3 (cot $\alpha = 3$ )			
$h$	Depth of canal	8 m			
$b_w$	Width of the canal at the water surface	128 m			
$b_b$	Width of canal bed	80 m			
$A_m$	Max. wet cross-section of ship (loaded)	75.24 m <sup>2</sup>		22.75 m <sup>2</sup>	
$L_s$	Length of ship	153 m		80 m	
$B_s$	Width of ship	22.8 m		9.5 m	
$y$	Distance of ship axis from canal axis	0	30 m	0	30 m
$y_s$	Distance at the water surface between side of ship and canal side slope (= $1/2 b_w - 1/2 b_s - y$ )	52.6 m	22.6 m	59.3 m	29.3 m
$T_s$	Draught of ship loaded	3.3 m		2.5 m	
$P$	Installed power of screw	2000 kW		200 kW	

The hydraulic loads after design are summarised in Table 8.6. The design parameters are thus the maximum return current and the maximum wave height (see Table 8.6) where selected values for  $\bar{U}$  and  $H_f$  are respectively 1.98 m/s and 0.60 m (see highlighted values in Table 8.6).

**Box 8.5** Example of typical results from a calculation procedure for slope protection due to ship-induced waves (contd)

	Parameter and symbol	Ship A		Ship B	
Step 1	Maximum ship speed, $V_L$	7.27 m/s		7.75 m/s	
Step 2	Sailing speed, $V_s$	$V_s = 0.60 V_L = 4.36$ m/s		$V_s = 0.70 V_L = 5.42$ m/s	
Step 3	Mean water level depression, $\Delta h$	0.9 m		0.9 m	
	Mean return velocity, $U_r$	1.27 m/s		1.06 m/s	
Step 4	Position relative to axis, $y$	$y = 0$	$y = 30$ m	$y = 0$	$y = 30$ m
	Max. water level depression, $\Delta \hat{h}$	0.90 m	1.42 m	0.90 m	1.94 m
	Max. return flow, $\hat{U}_r$	1.27 m/s	1.64 m/s	1.06 m/s	1.98 m/s
	Front wave, $\Delta h_f$	0.99 m	1.51 m	0.99 m	2.03 m
	Stern wave, $z_{max}$	1.35 m	2.13 m	1.35 m	2.91 m
	Secondary wave, $H_i$	0.21 m	0.28 m	0.48 m	0.60 m

### 8.3.5.3 Design of the cover layer against waves

For the design of the cover layer, the appropriate stability relationships can be found in Section 5.2.2.2, using the loading parameters determined in Step 4 (see Section 8.3.5.2).

The adapted formula of Van der Meer may be used to relate the revetment stability number and the various structural and hydraulic parameters such as interference peaks on the revetment (see Equation 5.143 in Section 5.2.2.2). The key design parameters are :

- $H_i$  = design wave height that should be used instead of  $H_{2\%}$  (m) (Equation 5.144)
- $P$  = notional permeability (-) (see Section 5.2.2)
- $S_d$  = level of damage acceptable, generally 2 for little damage (-)
- $N$  = number of ship passages, generally around 2000 (-) (see also Section 5.2.2.2)
- $\xi$  = surf-similarity number to be determined from wave characteristics and Equation 5.145 (-)
- $\Delta$  = relative buoyant mass density of the armourstone (-)

A first and simpler estimation of the armourstone size required can be made with Equation 5.146 given in Section 5.2.2.2. Section 5.2.2.2 can also be used where obliquity is generally close to  $60^\circ$ .

Finally, the stability relationship for the transversal stern wave is checked using Equation 5.147, with the parameter  $z_{max}$ .

### 8.3.5.4 Design of the filter layer

The need for a filter layer should be confirmed once the size of the armour layer is determined. A filter layer may be required, depending on the size of the subsoil material, to prevent transport of base material through the armour layer. Generally, a *geometrically closed* filter is chosen (see Section 5.4.3). The filter rule should be applied (see Section 5.4.3.6):  $D_{15f}/D_{85b} < 4$  to 5, where the subscripts  $f$  represents the overlying filter material and  $b$  the underlying (base) material, respectively. This allows a first estimate of the grading of the filter required. However, before this grading can be chosen as a filter layer, the subsoil should be checked to ensure that it is not too fine compared with the filter layer. Between the filter layer and the subsoil the same rule applies, which may lead to a filter composed of successive layers or alternatively, a geotextile.

If the **characteristic sieve size of the subsoil material**,  $D_{85}$  (m), is known, the filter rule between the subsoil and the granular filter should be checked to ensure the filter is geometrically and sufficiently closed (see Section 5.4.3.6). Otherwise a geotextile should be placed under the filter layer.

Coarse armourstone may also be used in combination with a **fascine mattress** (see Section 8.1.3.7).

## 8.3.6 Issues that influence design

### 8.3.6.1 Construction Issues

The issues to consider during the design with reference to the construction of armourstone works in canals in are very similar to those for rivers that are discussed in Section 8.2.9 and Chapter 9. However, the following aspects deserve some attention:

- when **constructing a new canal** it is often possible to carry out the works in dry conditions. This reduces the difficulty of placing a armourstone revetment, including any geotextile and gravel underlayers. Quality control during construction is much easier in dry conditions and the design tolerances can be more accurately controlled, for example the thickness of the armourstone layer or the levels of the prepared foundation (see Chapter 9)
- for **irrigation canals**, it is possible to drain the channels for a certain period or periods in the year, allowing construction works to be carried out in dry conditions
- for **navigation and water conveyance canals** this is often not possible and the construction for revetment works has to be completed underwater. This has several major impacts on the design (1) placing of the underlayer, either geotextile or gravel, may become problematic (2) thickness of the protection layer may have to be increased to allow for lower control of the armourstone placing (3) tolerances on excavation prior to placing the revetment need to be greater than when carried out in the dry.

### 8.3.6.2 Maintenance Issues

Maintenance issues for canals are similar to those for rivers as discussed in Section 8.2.10 and Chapter 10. The main maintenance activities in canals may include dredging to remove accumulations of silt, removal of excessive weed growth from the bed and banks, inspection, and repair of revetment systems. Some specific aspects are:

- in **irrigation canals**, it is frequently possible to close down the canal for annual maintenance. This eases the maintenance operation and allows inspection of works that are normally submerged
- in **navigation and water supply canals**, all maintenance will have to be carried out while the canal is operational

- the maintenance operations in a **navigation canal** may produce critical loading conditions for a revetment, for example if a dredger constricts the waterway causing high current velocities. There is also a risk that the dredger may disturb or damage the revetment at or near the bed.

It is important during the design stage to determine what the maintenance regime will be, and thereby tailor the design to suit the conditions that will be experienced in the maintenance process.

### 8.3.6.3 *Repair and upgrading*

These aspects are discussed in Section 8.2.11 for rivers and are similar for navigation and water conveyance canals.

## 8.4 **ROCK WORKS IN SMALL RIVERS**

Armourstone is used extensively in small rivers and streams to stabilise the bed and banks, and sometimes to provide environmental features such as riffles. For example, Figure 8.43 (left) shows very low flow conditions and riverbanks completely hidden by vegetation growth after the first few years of operation. Two types of small rivers can be distinguished:

- **lowland rivers** that are discussed more extensively in this section
- **mountainous rivers** or torrents (see Figure 8.43 (right)) for which water regime and sediment transport may be more variable and important; these are beyond the scope of this manual.

Using rock is preferable to concrete and other materials because it has a natural appearance, both in terms of the material itself and the surface finish. The gaps between the individual stones in a armourstone revetment can provide habitats for a wide range of water creatures. Where sediment collects in the gaps it promotes the growth of vegetation, which helps the construction works to blend into the surrounding environment. However, especially for mountainous rivers, grouting may be required as the only solution to keep armourstone in place.

In river channels that are used for pleasure craft navigation, stone on riverbanks can create a risk of damage to boats attempting to moor. Alternative forms of revetment are more appropriate, but if armourstone is used it may be necessary to display warning signs.

There are thousands of kilometres of small rivers and streams and they provide a valuable environmental and social asset. It is vital when planning works on these rivers to widely consult with all relevant parties, including those with an interest in navigation, recreation, angling, wildlife, heritage and visual amenity. It is important to note that there may be legal issues to address before construction works in rivers can commence, ie land ownership, planning permission, and consent from the regulatory bodies.

It is also vital that engineers working on such schemes consult with fluvial geomorphologists and landscape designers where appropriate. This will ensure that the works do not interfere adversely with the channel morphology or the surrounding environment and that they are sustainable in the long-term.





**Figure 8.43** Example of armourstone used in a small river: (left) rock revetment used to protect a storm drain outfall structure on an upland river in Richmond (UK) (courtesy C Rickard) and (right) control of torrent in the vicinity of Felkskanal (Austria) (courtesy I Lotherat)

### 8.4.1 Types of structure and functions

Some of the common types of rock structure used in small rivers are described in this section, with particular reference to European practice:

- **Revetment:** Revetments are one of the most common structures used in small rivers which can address the problems of local erosion on a riverbank, and where continued erosion would threaten the safety of adjacent infrastructure, such as a sewer, road, or a flood defence (see Section 8.2.2.1)
- **Scour protection:** Armourstone revetment placed on the bed of a channel are referred to as scour protection, although it is essentially the same form of construction as that used on banks. Scour protection is used in situations where erosion of the bed of the channel would threaten to undermine a structure such as a bridge, weir, sluice or culvert (see also Section 8.5.3)
- **Riffle:** A riffle in a natural channel is a short reach of faster flowing water, usually associated with a deeper pool of water downstream. Artificial riffles are introduced into streams to improve the environmental status of the channel, so that it is more attractive to fish and other wildlife, as well as improving the appearance (see Box 8.6)
- **Weir:** Armourstone weirs are provided in small rivers predominantly for environmental reasons. A weir can improve the visual appearance of a stream, creating a contrast between the pond water upstream and the faster flowing water downstream. However, weirs can also restrict the movement of fish unless the drop in water level is very small, ie less than 0.30 m for coarse fish (see also an introduction on fish passes in Section 8.5.2)
- **Retaining wall:** Where there is insufficient space available to allow the construction of a revetment, a retaining wall may be constructed (see Section 8.1.2)
- **Groynes:** In lowland Europe, groynes or spur-dikes are rarely used for small rivers, but can be useful for river training on steeper hill streams. Small groynes can also be used to create local environmental features, by slowing down the flow and causing sedimentation.

### 8.4.2 Plan layout and overall concept

The guidance given on river training works (see Section 8.2) is often applicable to small rivers. However, the following points are particularly relevant to small rivers:

- drawing up plans at an early stage in the design process will allow the design engineer to work closely with a **geomorphologist** and **landscape designer** to determine the most appropriate plan for the works
- rock structures intended to prevent **scour** or **erosion** should be designed to have as little impact as possible on the channel hydraulic performance. Rock structures should not intrude on the channel unless designed for that purpose, eg in the specific case of a weir or a groyne
- the alignment of revetment works should follow a **smooth curve**, preferably along the line of the existing bank, unless the bank is deliberately being reinstated on a different line. The terminations of the revetment should run smoothly into the natural channel beyond to avoid creating an area of turbulence in this vulnerable area (see Figure 8.44)
- the **plan locations** of the works are self-defining, which is specifically the case with a revetment to protect an eroding bank. However, it may be difficult to determine the starting and ending points for a revetment, because the length of bank affected by erosion may not be clearly demarcated. Areas of severe erosion will be obvious, but these generally taper out to stable banks. There may also be reaches with unaffected bank between eroding sections. For both environmental and financial considerations, the length of revetment should be the minimum practicable. However erosion is an ongoing process and unprotected reaches of bank may continue to erode.



**Figure 8.44** *Aerial photograph of an armourstone revetment required to stop erosion of the bank exposing contaminated soils. Note: The alignment in Figure 8.44 follows the line of the bank and ties into more stable bank at either end. The retention of shrubs in the riverbank (courtesy Mott MacDonald)*

### 8.4.3 Cross-section design

#### 8.4.3.1 General

Typical cross-sections of the works should be prepared in the early stages of the design process. For short lengths of revetment one typical section may suffice and this can be adapted to suit variations along the riverbank as the design progresses to the detail stage. For more extensive works, several cross-sections may be required to define the works at the outline design stage.

For a revetment to protect an eroding riverbank, the following factors should be considered in developing an appropriate cross-section design:

##### Slope of the revetment

The slope of the revetment is determined by a number of factors including:

- **slope** of the existing banks
- **geotechnical stability**
- local **landscape** and amenity
- **safety** to possible users, ie risk induced by a steep slope to people or livestock.

If the decision is made only on economic grounds, the slope would be as steep as practicable. A slope of 1:1.5 is normally the steepest practicable slope for dumped armourstone. Slopes flatter than 1:3 become very expensive because of the quantity of stone required and the plan area increases. In the absence of any other information, an average slope of 1:2 may be used for outline design.

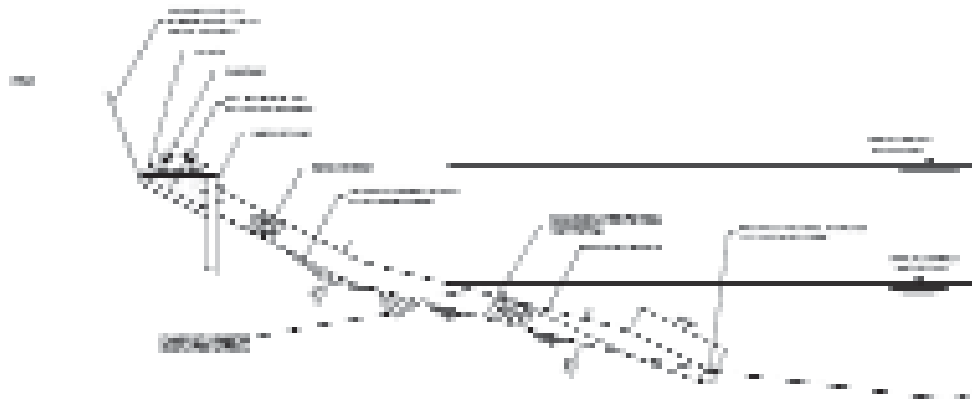
##### Composition of the revetment

The design of the revetment system is detailed in Section 8.2.6. This includes the armourstone grading to be used and thickness of the armour layer, the grading and thickness of the underlayer. For further information on grading and thickness as well as on the type and specification of geotextiles, refer to Chapter 3. For lowland rivers the most common application involves placing armourstone directly onto a geotextile underlayer, ie without a granular layer. This is possible because the sizes of stones are generally modest, and therefore the risk of damage to the geotextile during armourstone placement is limited. For mountainous rivers, grouting of the revetment may be required to limit the armourstone size required. However, ungrouted armourstone would provide more energy dissipation.

Figure 8.45 shows an example of revetment that was designed to prevent further erosion of the riverbank on the outside of a bend. A *weighted toe* was used to assist placing under water and to help retain the stones. The *weighted toe* is formed from a geotextile sock that is attached to the bottom edge of the geotextile layer; the sock is filled with sand or stones to provide the necessary weight. The armour layer is directly placed on the geotextile filter without a granular underlayer. The retention of a *cliff* above the winter flood level and the planting at this level were created to give a more natural appearance to the completed revetment.

The appropriate geotextile should be selected as a function of the nature of the foundation soils, the size and gradation of the stones, the proposed method of placing the stone, and details of the hydraulic loading (see Section 3.16). This controls its filtering capacity, strength and durability required (see Section 5.4.3.6).

It is possible to construct an armourstone revetment without any underlayer, with the stone being dumped directly onto the riverbank. This approach can be used as an emergency measure when it is necessary to stop ongoing erosion quickly. Such a revetment may not be as effective as a suitably designed structure with appropriate underlayer(s), but can be acceptable under certain circumstances. If armourstone is being placed without an underlayer, the grading should be wide (see Section 3.4.3.1). The thickness should also be increased above the minimum obtained from the recommended formulae. These two factors will help to reduce the risk of erosion to the subsoil causing collapse of the revetment. The effect of low cost revetment design on maintenance is discussed in Chapter 10 (see Boxes 10.6 and 10.9).



**Figure 8.45** Typical cross-section of a revetment (courtesy Mott MacDonald)

#### Revetment toe

The toe of the revetment provides stability and protects against undermining. For small rivers the toe can be an extension of the revetment onto the riverbed. The need for scour protection and its extension and depth is a function of the anticipated scour depth (see Section 8.2.7.3). The scour depth can be estimated by examining river cross-sections to see how the bed level varies along the reach in question. The deepest bed level observed gives a value for the minimum scour. This estimate may be refined through access to more accurate information, such as observed scour holes in the river outside the reach in question or calculations. If there is doubt over the scour depth, the advice of a fluvial geomorphologist should be sought. (see also Box 8.2 on falling apron and Section 5.2.2.9). Different toe details and scour protection solutions are available as shown in Section 8.2.7.6. In small rivers, a revetment should extend along the bed by at least twice the anticipated scour depth.

#### Stability

If there has already been a major slip in a riverbank due to a deep-seated slip surface, the addition of a revetment and toe will not yield significant improvements in stability and further movement may occur. It may be necessary to stabilise the toe with steel sheet piling, piles or a gabion retaining structure, or to adopt a more stable bank slope. These works should be designed by a competent geotechnical engineer (see Section 5.4).

#### Berm

A berm in the revetment may not be required in small rivers and streams. However, if there is a flood embankment located close to the edge of the river, then a berm is necessary at original ground level for ease of construction. Ideally this berm should be wide enough to accommodate maintenance plant, and to provide greater flow capacity in the river during floods, but a narrower berm may be acceptable if space is limited.

### 8.4.3.2 *Forms of revetment using stone*

The most commonly used stone revetment system in small rivers is dumped rip-rap, placed by machine. Alternative forms of revetment using armourstone in small rivers include:

- **single layer of pitched stone** (see Section 8.1.3.7)
- **mortared pitched stone**, ie with the gaps between the stones mortared, sometimes laid on a concrete backing. Mortared pitched stone is not recommended when the structure should allow for deformation or if settlement is expected
- **gabion boxes or gabion mattresses**. These can make use of smaller stones than would be required for rip-rap, and box gabions can form retaining structures (see Section 8.6.2)
- **mastic grouted revetment** and **masonry** are not in common use for river works. Masonry may be used for the repair or reinstatement of old structures (see Section 8.6.1).

### 8.4.3.3 *River restoration*

In recent years there has been a move away from heavily engineered river works and a trend towards creating more natural restored rivers. The straightened channels with uniform trapezoidal cross-sections without vegetation, which were the hallmark of land drainage works for much of the twentieth century, are now no longer socially and environmentally acceptable.

Quarried rock is often used as part of the restoration process to ensure that the restored channel is stable, without detracting from its more natural appearance. An example of this type of work is presented in Box 8.6. This structure was designed to suit site-specific criteria and may not apply to other locations.

1

2

3

4

5

6

7

8

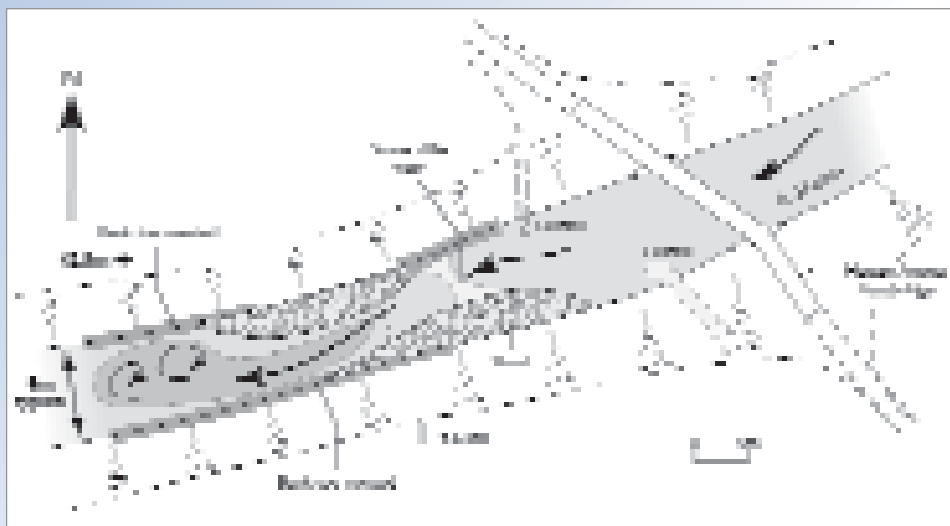
9

10

**Box 8.6** Using armourstone to enhance straightened river channels – stone riffle (courtesy UK River Restoration Centre)

A stone riffle was constructed in the river Skerne near Darlington in the UK as part of a river restoration project. The riffle provides recreational and environmental benefits in what was once a featureless, straight reach of river. As this reach of the river Skerne has no natural gravel sediments, the introduction of a stone riffle feature had to be entirely artificial and self-sustaining.

The structure was designed as a low sloping weir, linking two semi-elliptical shoals (see Figure 8.46 for plan view and Figure 8.47 for cross-section view). Scour of the structure, riverbed and banks downstream, was a primary design consideration. During low flows, only the weir is submerged but the shoals drown as flows increase. The configuration sustains a deep, faster flow of water around the downstream shoal that eddies as the currents merge with the lower river. The riverbanks are graded as flat as practical for easy and safe access to the water's edge. The toes of the riverbanks have armourstone revetments to protect against erosion in zones of accelerated flow.



**Figure 8.46** Plan of stone riffle

The armourstone used for construction was a wide graded crushed rock of 5-300 mm. At least 50 per cent of the material was in the range 125-300 mm to prevent washing away during floods, while allowing some adjustment to form. The structure was covered in a layer of smaller crushed stone, smaller than 75 mm, to simulate gravel and to smooth out irregularities. Much of this material would be washed away by floods, but was expected to settle out in niches close downstream.

The riffle/weir has performed well and adds greatly to the amenity of the location. The river has scoured away much of the smaller sized stone, as anticipated, but a stable structure has now evolved.



**Figure 8.47** Cross-section through the weir

Further information on river restoration techniques using armourstone, and some other types of materials, can be found in the *Manual of River Restoration Techniques* (1999 and 2002) from the UK River Restoration Centre (see also <http://www.therrc.co.uk>).

## 8.4.4 issues that influence design

### 8.4.4.1 *Materials aspects*

In the **smaller rivers in lowland** Europe, the hydraulic loading on armourstone structures is relatively modest. Flow velocities rarely exceed 2.5 m/s, wind-generated waves are small and waves from boat wash are not severe. In these circumstances the size of armourstone required to provide protection to eroding banks can be small. Consequently, there are more suitable sources of armourstone than is generally the case for large river projects or coastal works (see Section 3.1.1). Wherever possible, local sources should be used, which allows cost savings and reduces environmental impacts due to transport. When considering landscape aspects, large stones will look out of place in such an environment. Thus, the armourstone grading used should be as small as possible while still being sufficient to offer the required degree of protection.

The use of low durability and low quality stone, eg soft or cracked (see Section 3.6), should not be considered unless the protection works are temporary. This situation might occur in the case of a river diversion for example, either because the diversion itself is temporary, or because the structure incorporates plants such as willow that will grow, reinforce the bank and finally make the stone redundant after some time.

Angular stones are preferable to rounded stones because they provide more interlock, which makes the structure more resistant. However, stones used in gabions can be angular or rounded and the latter tend to produce more flexible structures when used in a mattress.

For example, the local armourstone described in Table 8.1 was used for construction of a revetment on a small river, in a layer with a minimum thickness of 600mm. It was laid on a 1:2 bank slope, with the stones placed directly onto a 10 mm thick non-woven geotextile. The relatively thick geotextile ensures that the stones do not puncture it during placing.

In **mountainous rivers** where currents may be important at the peak period of snowmelt, heavy gradings may be required (several tonnes in some cases). Local availability of such gradings is sometimes limited in the vicinity of the project and transport from a neighbouring valley may be costly. The material supply should be considered early in the project.

High quality material should be used because armourstone will often be exposed to:

- **high attrition** phenomena due to sediment transport
- **impact of boulders** and other materials such as trees during flood
- **severe environmental conditions** such as severe freeze and thaw. In addition, structures in the vicinity of roads might be exposed to de-icing salt.

Consequently, quality and durability of armourstone should be carefully studied early in the project (see Section 3.6) and controlled during supply (see Section 3.10). When the quality of a local source may not be sufficient, oversizing or grouting of the cover layer may be necessary.

If locally available armourstone gradings are too small for effective use as rip-rap, the use of gabions or grouting should be considered (see Section 8.6.2).

### 8.4.4.2 *Construction aspects*

It is important to consider how the works will be constructed as part of the design process and, if necessary adaptation of the design is required to overcome any constraints (see also

Section 8.2.9). The most common constraints are:

- difficulty of gaining **access** to the site to deliver plants and materials
- lack of **working space** to use the construction plant efficiently, in particular for works carried out in urban areas, but also where mature trees fringe a river (see Figure 8.48)
- the risk of **environmental damage** during construction, including disturbance to communities due to transportation of materials and equipment, disturbance to wildlife in the river corridor, damage to the river environment and ecology, pollution of the watercourse, etc
- changing **flow conditions** in the river, seasonal and daily.

Figure 8.48 shows a similar revetment as in Figure 8.45, but in this reach a mature tree was retained to lessen the adverse visual impact of the stonework. The root bowl has been isolated from the armourstone revetment using larch *spiling*. *Spiling* is a woven fence made from willow or larch, which is used to form a low-height retaining wall to an exposed stream bank. The fence panels have vertical poles with a typical diameter from 50 to 75 mm spaced at regular intervals (typically around 200 mm). The larch or willow spiling fence is woven between these poles, which are driven into the ground to provide support for the fence. When willow is used the intention is that some growth will occur, forming a more stable edge to the stream. Note that trees that are vulnerable to collapse or that would unduly obstruct flood flows, should be removed prior to placing the revetment.

Although these are issues to be resolved in the planning stage of the construction works, awareness at the design stage could offer the opportunity to revise the design and reduce the problem during construction. For example, if the river in question is regulated for navigation, ie there is no opportunity to lower water levels, the use of standard geotextiles for the underlayer should be envisaged with appropriate placing technique otherwise the contractor may have difficulty while placing it (see Section 9.7). Alternatively, a geotextile impregnated with sand may be more appropriate, which can be sunk into place.



**Figure 8.48** *Revetment incorporating mature tree (courtesy Mott MacDonald)*

The designer should be aware of what is practically achievable on site when drafting the specification. Engineering with armourstone is not a precise science and may not need excessively accurate tolerances especially for smaller works. In addition, if accurate tolerances are specified, they may be irrelevant because of the impossibility to check them on site. For example, the thickness of a armourstone revetment will be affected by the tolerances on the trimming of the riverbank, the variation in the stone size and the ability of the plant operators to place the stones evenly (see Section 3.5.1 and Sections 9.8.1 and 9.8.2). Requiring accuracy greater than 50 mm for the thickness is generally not practical and 100 mm is more realistic. Actual tolerances should be specified as a function of stone size.



### 8.4.4.3 **Maintenance aspects**

Most small rivers require little maintenance since they are, in effect, designed to be self-maintaining. Indeed, much of the environmental value of small rivers and streams derives from their natural state, with considerable benefits in terms of visual amenity and ecology. In these circumstances, maintenance activities are confined to removing fallen trees and removal of invasive plant species.

However, some rivers need pro-active maintenance to optimise their drainage function. This can involve the periodic removal of excessive vegetation growth, perhaps twice a year, and possibly the removal of accumulated silt from the riverbed. Being aware of these activities will help the designer to select the most appropriate form of river training works.

The most important maintenance consideration in the design is to ensure adequate access provision is included for any maintenance activities that may be necessary. This includes access for plant and vehicles, and space for depositing any vegetation or silt removed from the river.

Disruptive maintenance activities can damage a structure, so it is important to study the design proposals with those responsible for maintenance. An important consideration will be the need to avoid damage to the toe of a revetment as a result of any de-silting or dredging of the river. Cutting vegetation on banks protected by a armourstone revetment should not cause any serious problems as long as the operator is aware of the presence of the stones.

If there are no plans for pro-active maintenance, it should be appreciated that the revetment may eventually be obscured by vegetation growth. This will make routine inspection of the works difficult. It may not be possible to detect any signs of early failure and this should be taken into account at the design stage of the revetment (see also Section 8.2.10 and Chapter 10).

## 8.5 **SPECIAL STRUCTURES**

### 8.5.1 **General**

In addition to the river training works described in the preceding sections of this chapter, armourstone is also used for a number of other structures found in rivers which include:

- pipeline and cable crossings
- weirs and fish passes
- scour protection to bridge piers
- anchoring structures.

Specific issues concerning these structures are briefly discussed in the following sections. Fish passes and scour protection are discussed in more detail. The presence of special structures in rivers or canals may have an impact on water levels, current velocities and local scour, which should be investigated. The impacts on water levels and on current velocities are also discussed in the following sections.

#### 8.5.1.1 **Water levels**

Any structure that restricts the waterway section may result in an upstream increase of water levels. Water levels can be influenced by pipeline and cable crossings if these structures form a sill in the river or canal. This effect is more pronounced for higher obstructions in the bed, eg if a pipeline is laid on the existing riverbed and then covered with a thick armour layer. Wherever possible, pipelines and cables crossing rivers and canals should be laid in a trench dredged in the channel bed. The trench can be backfilled with suitable material depending

on the erosive forces. In a canal, backfilling by sand may be acceptable, provided that anchors are not going to be used. For rivers it is more likely that an armour layer will be required to ensure that the pipe or cable is not exposed after some erosion of the bed.

If active erosion of the riverbed is anticipated, an armour layer to a pipe or cable crossing placed at bed level may end up as a sill in the bed. This can be avoided by locating the armour layer below the existing bed (see also Section 6.4 and Section 5.2.3.2).

### 8.5.1.2 **Current velocities**

Current velocities may be locally increased by any of the structures mentioned, but such increase is generally modest. However, greater obstruction to the flow leads to a larger increase in current velocities and the likelihood for eddies and turbulence is therefore greater. This can result in damaging local erosion. Weirs and fish passes span the river width and tend to slow the currents upstream. However, immediately downstream of the structure there will be high velocity turbulent flow that may erode the channel bed unless appropriate measures are taken to protect the bed.

In the case of anchoring structures and bridge piers, the local impacts can be severe if the structures are wide and not streamlined. Local erosion in the bed can be severe, especially in flood conditions.

For the particular case of piers and piles in rivers, the designer should consider the following alternatives:

- **no bed protection:** Scour of the bed is allowed and consequently a deeper foundation level for pier and/or piles is required. This will result in a large, free-standing height of pier or pile and hence greater vulnerability to ship impact and hydraulic loading
- **bed protection:** The provision of bed protection, unless carefully designed, can increase the obstruction to the flow in the channel, thereby worsening the effects of local currents and turbulence (see Section 4.3.2.4 and Section 4.3.2.5).

## 8.5.2 **Fishways**

### 8.5.2.1 **General**

A **fishway** or **fishpass** is a structure that enables fish to swim upstream around obstacles such as weirs, sluices and dams which can present a barrier to the fish displacement.

Even relatively modest weirs, with a drop in water level of only 0.3m can prevent the migration upstream of some fish species. To accommodate the upstream migration of fish a bypass channel can be constructed in which the water level is brought down through a number of small steps. This can be achieved by creating a number of small weirs with intermediate pools in the channel in such a way that the difference in water level over each weir is small enough for fish to be able to pass. A fish pass requires sufficiently large pools – both in depth and in area – to allow a natural passage for the fish expected to swim upstream through fish passes.

The design of a fishway requires knowledge of the behaviour of the fish. The most important aspects are:

- **migration period:** determining the availability of the fishway in reference to the different river discharges
- **swim capacity:** determining the maximum current velocities at the weirs and the dimension of the pools

- **orientation:** determining the interaction between the river weir and the fish entrance of the fishway.

The main species should be recognised because each fish species behaves differently. The swim capacity is different for each species and depends on the size of the fish. For example salmonids are strong swimmers and cyprinids often have a low swimming speed (Winter and Van Densen, 2001, Larinier et al, 1994). The current velocity within the fishway should be lower than the maximum swim capacity of the target species. If there are parts of the fishway in which the current velocity exceeds the maximum swim capacity, it is necessary that fish can rest in a pool. In the pools downstream of the weirs the high current velocities drop and eddies provide suitable resting areas for the fish.

Besides the ecological design criteria there are also technical boundaries such as:

- differences in **discharges** and **water levels**
- **weir operating** management
- **balance of economic** benefit between requirements for hydro-power station discharge against the optimal current for attraction of some fish species,  $Q_{fishway}/Q_{river} \approx 3$  per cent.

Fishways are mainly built using concrete but stones can also be used to create artificial rivers and protect the weir. A recent development of fishways in the Netherlands using stones is presented in Section 8.5.2.2.

### 8.5.2.2

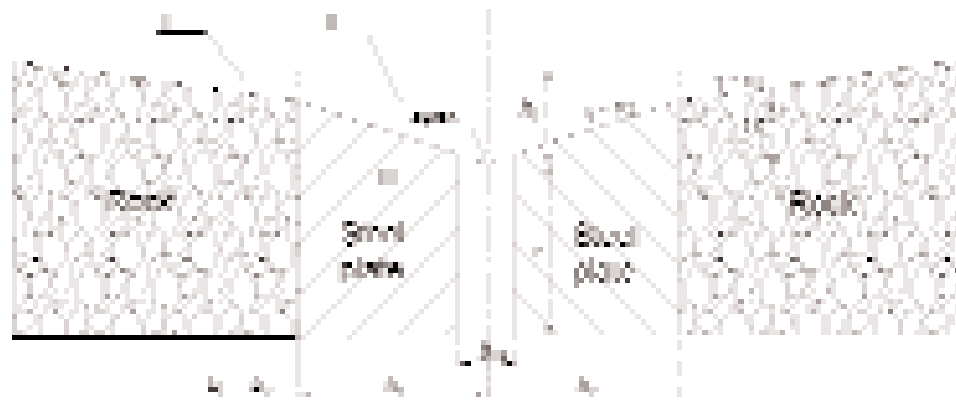
#### **Recent experience with V-shape fish pass on the River Rhine**

In the Netherlands some large spacious open channel weir-pool fishways were recently constructed in the Nederrijn/Lek branch of the River Rhine. The discharge through the Rhine fishways was set at 4 m<sup>3</sup>/s.

In the fishways of the Rhine an innovative weir shape was adapted from a combination of the two standard weirs: the V-shape weir and the vertical slot weir (see Figure 8.49). This V-shaped weir with vertical slot combines the positive characteristics of the standard weirs, ie the large variety in flow pattern and velocity over the weir enabling the passage of different fish species, and eliminates the disadvantages, ie sensitivity to variation in water level and head difference. Figure 8.50 indicates the cross-section of V-shaped weir with vertical slot.



**Figure 8.49** Fishway in the River Rhine showing V-shaped weir with vertical slot (courtesy Rijkswaterstaat)



**Figure 8.50** Cross section of the V-shaped weir with vertical slot (courtesy Rijkswaterstaat)

The swim capacity of the fish over short distances controls the maximum allowed local current velocity indicated by section III of Figure 8.50 (about 1.7 m/s in the case presented in Figures 8.49 and 8.50). Using Box 8.7, the head difference ( $h_1-h_2$ ) can be calculated ( $(h_1-h_2) \approx 0.16$  m). Then, with the input of the maximum allowed discharge it was possible to optimise the dimensions of the weir.

Finally, the total head difference is divided by the maximum head difference per weir to determine the minimum number of weirs (in this case, the maximum head difference over the total fishway equals 3.8 m, so 24 weirs were required). The length of the pools between the weirs should be sufficient to allow the fish to rest (at least 10 m in this case). The dimensions of the pools are determined by the maximum current velocity (about 0.8 m/s) based on the swim capacity of the fish over long distances, and the maximum discharge (of 4 m<sup>3</sup>/s). The length of the pools and the number of weirs determine the minimum length of the fishways (230 m here). Furthermore it is important that the bottom of the vertical slot is flush with the adjoining bed to prevent the occurrence of unwanted turbulent areas near the bed.

The stability of the steep side slopes made of armourstone (1:1.5 measured along the flow direction) in area I depends on the water flow in this part. In determining armourstone grading, high river discharges should also be considered when the adjustable weir in the river is lifted and water levels in the floodplain rise. The required size of the stones can be assessed using the methods described in Section 5.2.3.

Area III also requires armourstone as bed protection. Determining the grading of armourstone in this section can be complicated because of the local hydraulic situation. The flow through the vertical slot determines the dominant hydraulic load, because the overflow in area II does not reach the bed due to the jet stream occurring in area III. The overflow in area II, however, influences the jet stream occurring in area III: the overflow decreases the loss of energy in the jet compared with the more or less stagnant water above the jet. It also pushes the jet onto the bed.

The local flow velocity  $u$  in the vertical slot equals  $\sqrt{2g\Delta h}$ . Using the jet description, according to Rajaratnam (1976) the spreading of the flow over the bed can be calculated. Using a stability formula, eg Pilarczyk or Shields (see Section 5.2.3) the stone size in area III and further downstream in the pool can be determined.

**Box 8.7** Calculation of discharge in a V-shaped weir with vertical slot using armourstone

The discharge relation of this type of fishway is given by Equations 8.4 and 8.5 (WL|Delft Hydraulics, 1998) for two different water depth situations (see Figure 8.50 for parameter definitions):

for  $h_1 \geq 1.25 H_b$ :

$$Q = C_{SI} \mu_I \left(\frac{4}{5}\right)^2 \sqrt{\frac{g}{2}} \tan\left(\frac{\theta_1}{2}\right) (h_1 - H_b)^{2.5} + C_{SII} \mu_{II} \frac{2}{3} \left(\frac{2}{3}g\right)^{0.5} 2H_b \tan\left(\frac{\theta_2}{2}\right) \left(h_1 - \frac{1}{2}H_b\right)^{1.5} + 0.8 b_{vs} P \sqrt{2g(h_1 - h_2)} \quad (8.4)$$

for  $h_1 < 1.25 H_b$ :

$$Q = C_{SII} \mu_{II} \left(\frac{4}{5}\right)^2 \sqrt{\frac{g}{2}} \tan\left(\frac{\theta_2}{2}\right) (h_1)^{2.5} + 0.8 b_{vs} P \sqrt{2g(h_1 - h_2)} \quad (8.5)$$

where:

$\mu$  = discharge coefficient depending on the upstream energy head above the apex, the crest width and the geometry of the crest (-); for this type of weir:  $\mu_I \approx 1.1$  and  $\mu_{II} \approx 0.6$

$C_S$  = correction factor for subcritical flow depending on the value  $h_1/h_2$  (-); for this type of weir:  $0.75 < C_S < 1$

$H_b$  = height of the kink relative to the apex (m)

$h_1$  = upstream water level relative to the apex level (m)

$h_2$  = downstream water level relative to the apex level (m)

$P$  = height of the vertical slot (m)

$Q$  = discharge ( $m^3/s$ )

$\theta$  = opening angle of the V-shape ( $^\circ$ ) =  $\tan(\theta/2) = n_i$ ; for this type of weir  $n_1 = 7$  and  $n_2 = 3$

$b_{vs}$  = width of the vertical slot (m)

**8.5.3****Scour protection of bridge piers**

One of the main causes of bridge collapse is scour which can undermine the foundations of bridge piers. To easily avoid this problem, it is recommended to construct the foundations of the bridge deeper than the maximum anticipated scour depth, wherever practical. However, there are circumstances where this option is not viable, due to the costs associated with creating deep foundations in difficult conditions. In this case, the provision of some form of scour protection can provide an acceptable alternative approach.

Scour in rivers can occur as a result of a number of processes, introduced here (see also Section 8.2.6.1). For a more comprehensive reference on scour and ways of protecting against it, the reader is referred to the *Manual on scour at bridges and other hydraulic structures* (CIRIA, 2002) and/or the *Scour Manual* (Hoffmans and Verheij 1997).

- **natural scour:** This includes general lowering of the bed as part of a long-term or seasonal response to flow conditions. It also includes scour due to channel migration, ie where a deep water channel moves laterally towards bridge piers with shallower foundations. Natural scour also includes bend scour, the tendency for deeper bed levels on the outside of a bend
- **contraction or constriction scour:** This results from confining the width of a channel and thereby accelerating the flow, eg as a result of constructing bridge piers
- **local scour:** Caused by an obstruction in the flow, such as a bridge pier or a spur head.

These aforementioned scour processes can occur simultaneously, resulting in greater scour depths than would result from any process alone.

To design the appropriate scour protection, the designer should determine the extent of scour, ie the area of the bed affected as well as the depth of scour. In the absence of more detailed information from field observations or model tests, the designer may apply the following rules of thumb for preliminary design of protection to bridge piers (assuming  $b$  is the projected width of the pier at right angles to the flow direction):

- local velocity at the scour protection can be estimated to  $v_s \approx 2U$ , where  $v_s$  is the velocity at the scour (m/s) and  $U$  is the depth averaged flow velocity (m/s) (LCPC, 1989)
- median stone size can be estimated as  $M_{50} \approx (4/25)U^2$
- minimum extension of protection can be estimated as  $2b$  to  $3b$  from the edges of the pier, each side
- thickness of the protection can be estimated to  $2 \cdot b$ .

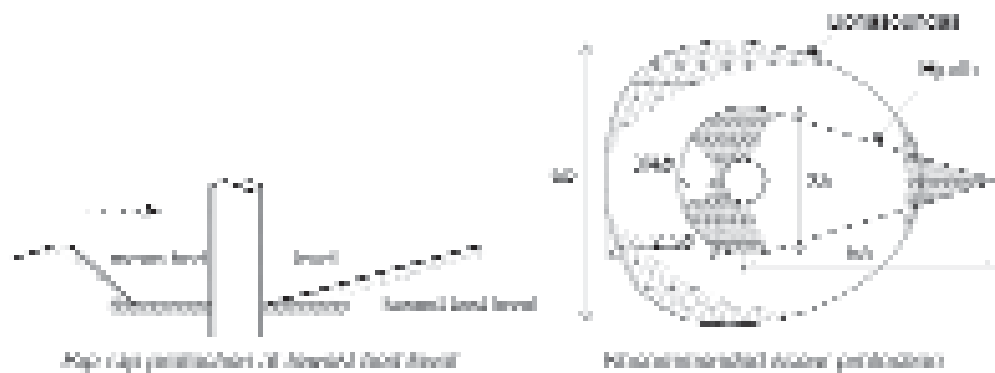
It is recommended that the design is supported with detailed studies, possibly including physical modelling tests.

Detailed studies were performed by several authors on the required extension of scour protection as illustrated in Figure 8.51 (for further reference see the *Manual on scour at bridges and other hydraulic structures*, CIRIA (2002)). Where groups of piles support a foundation, model studies are recommended. For safety, the group of piles may be considered as a single structure.

Scour protection should be constructed when the bridge foundations are constructed, while it can be accurately placed. It should preferably be placed at the upper surface no higher than the existing bed level to avoid creating more of an obstruction to the flow. If the scour protection is to be constructed after the bridge has been completed, in response to concerns of scour risk, then dumping of armourstone is preferred. However, a cautious approach is recommended since excessive dumping can exacerbate the problem by creating further obstruction to the flow.

When constructed in the dry at the time of completing the bridge foundations, the scour protection can incorporate a geotextile filter and/or a granular underlayer that will reduce the risk of washout of bed material. It is also possible to incorporate a falling apron into the scour protection (see Section 8.2.7.4) that will accommodate future scour.

Gabion mattresses can also be used for scour protection at bridge piers, especially if the work can be completed in the dry. If necessary, the mattress can span the full width of the river to protect the entire bed at the bridge foundations. However, this may result in the formation of a weir if natural scour lowers the riverbed upstream and downstream. Placing mattresses underwater at bridge piers is not a straightforward operation and should not be the first option. However, if it is to be carried out to create a suitable underlayer to armourstone, then the mattresses will need to be tailor-made, and careful planning will be required to ensure that the mattresses can be sunk accurately into position, and that transitions with the piers can be accurately constructed; for guidance on detailing of transitions see Section 8.2.7.6.



#### Notes

Bonasoundas (1973) and Hjorth (1975) are given for further reference.

$b$  = pier diameter

**Figure 8.51** Example of scour protection of a bridge pier

## 8.6 USE OF SPECIAL MATERIALS

### 8.6.1 Grouted stone with concrete or asphalt

#### 8.6.1.1 Definition and use

In waterways or rivers, the most common uses of concrete and asphalt are for :

- **open stone asphalt** which is a mixture of small stones and asphalt laid hot
- **mortared stone pitching** which is a hand-placed revetment with the stones bedded in cement mortar
- **blockstone** with bitumen or concrete grout.

Blockstone is only briefly commented on in this section, while the other uses of asphalt and concrete are discussed in more detail. For guidelines about grouting materials and associated requirements, see also Section 3.15.

Relevant information about practical methods can also be found in the German guidelines *Code of practice – Use of cement bonded and bituminous materials for grouting of armourstone of waterways*- MAV (BAW, 1990) and the Dutch guidelines *The use of asphalt in hydraulic engineering* (TAW, 1985).

The main type of structure using such grouted materials is bank protection. However, grouted stone is also used when hydraulic loads are too strong for free stones, eg for the construction of fixed weirs, protection downstream of weirs, bank or dike protection, erosion protection, bank retaining structures. They may accept very high current velocities up to 10 m/s.

Grouted stone can be used as bank protection when hydrodynamic loads are high and when the protection should have waterproofing or a bank support, eg if steep slopes are necessary.

The use of bitumen to grout the stones is more appropriate to bank protection than concrete for the following reasons:

- asphaltic mastic is less **sensitive to weathering** and allows a better contact with stones
- the use of concrete leads to a more **rigid structure** and is not recommended if a capacity to adapt to subsoil deformations is required.

However concrete has sometimes been chosen because it can be cheaper and its colour is less visible.

### 8.6.1.2 Dimensioning of stones and binder

#### Implementation

The structure of a revetment in bound armourstone consists of two layers of stones with binder.

There is limited theoretical guidance for the sizing of grouted stones. Sometimes, the armourstone is dimensioned with the rules of loose armourstone and the binder is only an additional security. For economic reasons, this choice is not often recommended, except if grouted stone is only necessary on a limited part of the project. This rule can also be used for partial grouting when all the stones are not bounded.

Some stones can be glued together resulting in an equivalent increased mass. Extreme situations are:

- for **dense binding**, a high bond strength is obtained and there is no risk of breakage between stones and thus no risk of stone extraction
- for **loose binding**, a lower bond strength is obtained and there is a risk of breakage between stones. The hydraulic stability of an equivalent stone, ie a group of two to eight stones, should be verified.

Finally, the sizing is determined by considerations on the thickness of the whole protection, ie stones and binder. For example, for grouted armourstone used to protect a bank, the geotechnical stability of the slope has to be verified, especially with reference to water pressure behind the grouted stone layer.

Moreover, it can be considered that the thickness of the structure should not be less than the value of  $D_{n50}$  obtained for free stones.

#### Armourstone characteristics

Armourstones should display appropriate quality and durability (see Section 3.6), should be free of cracks (see Section 3.3.4) and should not be sensitive to frost action (see Section 3.8.6). They should have regular or equant shapes and a marked angularity. The choice of armourstone gradation should take into account two essential criteria:

- the **penetration of the binder** into the spaces between the stones
- the **arrangement of stones** and how they are fitted against each other.

To ensure efficient penetration of the binder between the stones, the armourstone grading should satisfy the three following conditions:

- the **void size** in the armourstone should be compatible with the penetration of the binder, which may be expressed as follows :  $D_{n10} > (3 \text{ to } 5) D_{max}$  for asphaltic binders, where  $D_{n10}$  = the 10 per cent passing of armourstone and  $D_{max}$  = maximum diameter of the aggregates of the binder; for concrete binders other values may be applicable, detailed guidance of which should be sought from specialist institutes (see also Section 3.15.1)
- the **thickness of the protective layer**  $t_d$  established after a study of stability should verify the rule  $D_{n50} = t_d/2$ , where  $D_{n50}$  of the protection layer depends on the size of the work and is controlled by hydraulic actions (see also Section 3.5.1).



- the appropriate **gradation** should be determined from values of  $D_{n10}$  and  $D_{n50}$  obtained with the two constraints above. This usually results in a narrow grading (see also Section 3.4.3.1).

### Binder characteristics

Table 8.7 presents the properties of binders used in the hydraulic environment. Cementitious binders consist of sand, gravel, cement and water. For use in a hydraulic environment the cement content should be about 300-350 kg/m<sup>3</sup>, according to the aggressiveness of the environment. The mass ratio of water to cement should be lower than 0.55 (see also Section 3.15.1).

**Table 8.7** Properties of binders

Properties expected of the binder		These properties are controlled by:	
		For cementitious binder	For the bituminous binder
Mechanical properties	Resistance to wear by friction	Increased cement content	By nature resistant
	Mechanical resistance to tensile stresses and to shocks	Increased cement content	By nature resistant
	Resistance to freeze and thaw	Increased cement content	Asphalt content
	Flexibility	Not appropriate	By nature resistant
Physical properties	Resistance to weathering	Nature of the cement	By nature resistant
	Adhesion rocks-binder	Water/cement ratio	Nature of rocks
	Permeability	Cement content, gravel	Asphalt content, sand
Workability ie spreadability of material		Conditions of implementation, gravel	Temperature of implementation, sand content

#### 8.6.1.3

### Structure specific considerations

The intended design can be a permeable or an impermeable revetment. The decision to have a permeable or impermeable bank depends on the local hydraulic conditions. For example in a canal, an impermeable revetment is required to avoid leakage, on the contrary if the groundwater level in the banks is higher than in the river it is recommended to have a permeable bank.

The grouting can be partial or full (see Section 3.15). Full grouting is used for impermeable lining and for heavily loaded revetments where there are strong currents. If an impermeable lining is intended, an impermeable grouting material is required and the entire surface should be grouted.

A filter layer should be placed between the armourstone and the soil, especially if the bank is not impermeable.

For bank protection, grouted stone may be used when hydrodynamic loads are high, and when the protection should have a sealing and bank support function. However, due to the high rigidity of a grouted stone structure, there is a risk of voids developing beneath the armour layer which can be difficult to detect when it first occurs. To prevent this from occurring it is essential that filter and gradation rules for the subsoil are met (see Section 5.4.3.6) and that excess pressures cannot build up beneath an impermeable cover layer. Sometimes, a drainage system is used to avoid uplift pressures under the revetment (see Figure 8.36). The designer needs to pay attention to geotextile filters that may be sealed by the cement and these should not be used if a drainage function is intended.

Further structure specific information is summarised below:

- **fixed river weirs or sills**, see Table 8.8
- **banks**, see Table 8.9
- **protection downstream of weirs**, see Table 8.10.

**Table 8.8** *Practical considerations for the use of grouted stones in fixed river weirs*

Crest stability should be checked for	Possible measures
Uplift pressure	Weight of cover greater than uplift pressure or sufficient cohesion of the works to accept tensile stresses
Debris	<ul style="list-style-type: none"> <li>● crest with a little marked roughness</li> <li>● wide crest on streams exposed to debris</li> </ul>
Deformation of the structure body	<ul style="list-style-type: none"> <li>● study the settlement of the foundations (see Section 5.4)</li> <li>● appropriate compaction of the materials of the dike body</li> </ul>

**Table 8.9** *Practical considerations for the use of grouted stone in bank protection*

Sizing according to	Possible measures
Uplift pressure	Verification of the stability
Erosion	Additional thickness, which can be equal to one stone layer thickness
Permeability	<ul style="list-style-type: none"> <li>● non-permeable: composition described in Section 8.6.1.2</li> <li>● permeable: binder without fine elements</li> </ul>

**Table 8.10** *Practical considerations for the use of grouted stone in protection downstream of weirs*

Sizing according to	Possible measures
Uplift pressure	Calculation of stability with the hypothesis: <ul style="list-style-type: none"> <li>● connection with concrete sill perfectly sealed</li> <li>● weight superior to uplift pressure.</li> </ul>
Hydrodynamic load	Thickness of the cover layer equal to the diameter of loose stones that would have been required for stability in these hydrodynamic conditions

#### 8.6.1.4

#### **Other considerations for construction and maintenance**

##### **Construction issues that influence design**

The implementation should minimise voids in the armourstone layer. Consequently armourstone has to be placed carefully with good interlocking. Before any grouting the rock structure should be checked to confirm its construction is acceptable.

For better results, grouting of both layers of the armourstone at the same time is recommended. However, it should be verified beforehand that the formulation of the binder allows this.

The quantity of grouting material depends on the density of armour layer and on the required properties that are listed below:

- bond strength
- permeability
- depth
- flexibility.

The density of the grouting material should be about:

- 2 to 2.3 kg/l for **cement bounded grouting**
- 1.8 to 2.3 kg/l for **asphaltic mastic**.

When possible, better work quality is achieved in the dry. If a part of the protection has to be constructed underwater, the binder formulation should allow for this.

Tests performed for concrete or bitumen approval in other contexts have to be carried out (BAW, 1990). Moreover, specific tests of suitability are necessary to validate the grouting materials and the resulting grouted armour layer, in particular, with reference to penetration and permeability. A trial panel may be used to assess these properties on-site.

#### **Maintenance issues that influence design**

The binder can be the weak point in a grouted armour layer since it displays less mechanical resistance than the armourstone. In addition, it can suffer from frost, cracks and weathering prior to complete disintegration. Optimal properties can be obtained by a correct formulation of the material (see Section 3.15).

One of the main causes of degradation of bitumen binders, when used in marine locations, is induced by the development of seaweed. In this case the revetment has to be cleaned and protected by a surface mastic.

## **8.6.2 Gabions**

### **8.6.2.1 Use of gabions for river works**

Box gabions are principally used for retaining walls and spur-dikes, whereas mattresses are used for revetment and scour protection. Gabion compositions are presented in Section 3.14 and come in a range of sizes among which the most common are  $0.5 \times 1.0 \times 2.0$  m and  $1.0 \times 1.0 \times 2.0$  m. However, they may be tailor-made. Gabion mattresses vary in thickness from about 0.15 m to 0.50 m.

Durability of the structures depends on the durability of the filling stones, and the wire mesh boxes. River works generally require good protection against corrosion. The wires have a zinc or galfan (Al-Zn Alloy) coating, and where abrasion or chemical aggressiveness is a problem, or in marine environments, a plastic covering to the wires is also provided (PVC or polyethylene).

Gabions can be used for several types of works, combining erosion protection and retaining functions. Gabions and gabion mattresses are suitable for hydraulic works and should be designed to resist hydraulic conditions notably the velocity of water flow and wave height. They may be used for water velocities up to 6 m/s and wave heights up to 1.5 m. Where gabions may be exposed to very abrasive conditions, ie gravel or cobbles conveyed by fast flowing water, the upper surface of the gabions should be protected with a concrete or asphalt revetment.

Confined stones in gabion boxes provide more resistant structures to water flows than loose stone. With the same hydraulic conditions, the average dimension of the stones to be used may be significantly smaller, such as one-third of loose armourstone. In addition, tests performed at Fort Collins University (Colorado State University, 1988) shows that the Shields coefficient,  $\psi$ , (see Section 5.2.1.2) for gabions is three times that of standard loose armourstone: the value is around 0.14 for gabions and 0.04 – 0.05 for loose armourstone.

For loose stone, after initial movement of individual stones, they may be removed by the flow. However in the case of gabions, the containment offered by the mesh remains even after initial movement. A new situation of equilibrium with a deformed gabion mattress is achieved, providing protection without compromising the resistance, and without further deformation. This may not be the case if the foundation is exposed, allowing soil to be washed away and undermining the gabions.

With the same hydraulic conditions, the thickness of a gabion revetment is about one-quarter to half the equivalent thickness of rip-rap protection. However, integrity of gabions depends on the quality and durability of the wires as well as on the quality of construction, ie tying the gabions together and wiring the lids closed. Poorly manufactured gabion boxes or mattresses can be severely damaged by hydraulic forces, for example if wires are too thin or not protected against corrosion or loosely twisted together. They are also more prone to vandalism.

Gabions may be combined with bio-engineering applications including vegetation, tree cuttings, and grass mats that will provide a more natural aspect.

### 8.6.2.2 *Plan layout*

When using gabion mattresses or gabion boxes for hydraulic works, similar rules as those exposed in Section 8.2.5 should be applied. The principal aspects are the following:

- **determine the protection height** depending on the maximum water level of the river and wave action
- ensure hydraulic and geotechnical **stability** of the gabion revetment
- **influence of river geometry**: loadings are greater on the bank located at the outer part of a bend
- **influence of the work being designed** on the other parts of the river: considering the roughness of the gabion revetment, water velocities may be higher after the completion of the work
- **toe protection** is required to avoid erosion of the river bed along the structure. This requires a specific design which considers hydraulic conditions, geometry of the structure and nature of the ground
- **upstream and downstream anchorage** of the protection in the riverbanks to avoid excessive erosion at the boundaries that could lead to outflanking of the revetment.

### 8.6.2.3 *Cross-section design*

This section first presents typical cross-sections of gabions used as erosion protection or as mixed erosion protection and retaining wall. A methodology for design is then presented.

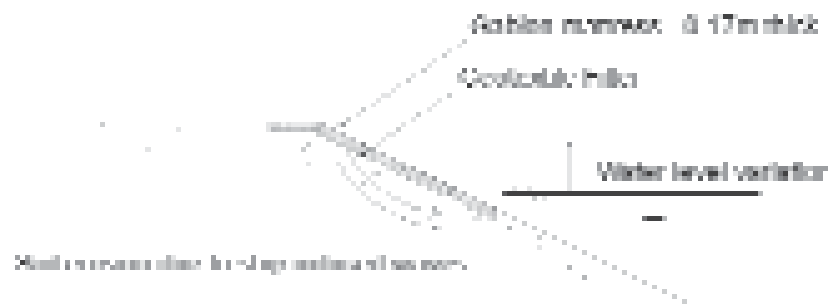
#### **Typical cross-section for gabions used for erosion protection**

Erosion protection may be applied to sections of bank lining or to totally lined banks. The protection needs to resist the different hydraulic erosion forces. The forces can be higher at the toe of the bank and smaller at the top of the bank, but not necessarily so.

For slopes that are geotechnically stable (see Section 5.4), a relatively thin gabion mattress may be used to provide protection against hydraulic erosion forces due to water flow or ship-induced waves. In these case the mattresses are directly placed on the bank subsoil. A non-woven geotextile is placed under the mattress to prevent erosion of the subsoil of the embankment (see Section 5.4.3.6) in the following cases:

- when bank **erosion caused by waves is expected**: protection is only required in the splash zone and should only cover the part of the bank around the water level (see Figure 8.52)
- when **erosion caused by currents is expected**: the most exposed part of the riverbank or bed should be protected (see Figure 8.53).

As a response to the intensity of erosive forces at the toe of the structure, the revetment thickness may be increased to resist erosion forces (see Figure 8.54) or a specific toe protection may be used (see Figure 8.55).



**Figure 8.52** Use of gabion mattresses for protection against waves of the upper part of the bank (courtesy Maccaferri, France)



**Figure 8.53** Partial or total lining of the section (courtesy Maccaferri, France)



**Figure 8.54** Thickening of revetment to provide adequate toe protection (River Thoré, France) (courtesy Maccaferri, France)

For the Thoré river protection (see Figure 8.54), the 1:100-year river discharge was estimated as  $Q_{100} = 225 \text{ m}^3/\text{s}$ . The revetment was designed and positioned on the banks and the thickness was increased with depth. Heavy gabions (0.5 m to 1.0 m thick) were used to cover the toe of the riverbank, while lighter revetments with mattresses (0.17 m to 0.30 m thick) were used higher up the bank. A geotextile filter was used to avoid erosion of the foundation material.

#### Typical cross-sections of gabions used as erosion protection and retaining wall

Occasionally, a bank protection also needs to be a retaining structure. In this situation, gabion walls may be used as hydraulic protection and mechanical reinforcement of the slope. In Figure 8.55, the gabion wall retains filled material placed between the existing bank and the new profile after realignment of the bank. Figure 3.100 shows the use of gabions with a retaining function behind armourstone.

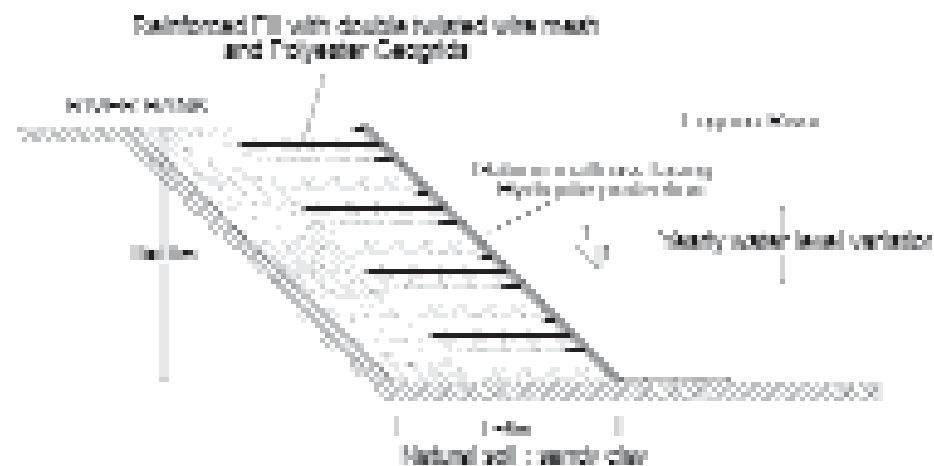


**Figure 8.55** Typical cross-section for gabion wall bank protection (courtesy Maccaferri, France)

The gabion wall needs to be designed considering hydraulic data, ie current velocity, wave height, and also considering geotechnical data for the retained soils and foundation. There may be a need for extra scour protection at the toe to prevent the wall from being undermined (see Figure 8.55).

For higher banks, the retaining structure can be made of reinforced fill with hydraulic protection of the facing. Figure 8.56 shows a 10 m high bank protection made of reinforced fill, with a facing of gabion mattress revetment. The design addressed the two following aspects:

- **hydraulic design** of the gabion facing which should withstand hydraulic conditions of the river
- **geotechnical design** that consists of the analysis of slope stability of the reinforced bank against soil failure and foundation settlement (see Section 5.4).



**Figure 8.56** Gabion bank protection which also performs a retaining function, Logone river, Kousseri, Cameroon (courtesy Maccaferri, France)

## Design and sizing of gabion revetments subject to water flow

Gabion mattress thickness is determined from the hydraulic forces using the following steps.

**NOTE:** Refer also to the design guidance for gabions given in Section 5.2.3.1.

### Step 1: Calculation of the gabion size

Rules of thumb are given in Table 8.11 for gabion mattress thickness, based on a range of current velocities. The guidance in the table does not take into account the real mechanism of erosion, ie shear stress, but it may be a sufficient approach at preliminary design stage. Values of critical (SLS) and limiting (ie ULS) velocities are given for preliminary design, considering horizontal protection (ie bed protection) and double diaphragm gabion mattresses. Note that *diaphragm* is the term used for the separation between the gabion cells, which for gabion mattresses is made of the bottom wiremesh folded (see also Section 3.14.1). Detailed calculations can be performed based on the shear stress acting on the gabions. General guidance on the design process is given in Box 8.8.

**Table 8.11** Indicative values of critical and limiting velocities for mattresses

Mattress Thickness (m)	Stone Size $D_{n50}$ (mm)	Critical Velocity (m/s)	Limiting Velocity (m/s)
0.15 – 0.17	85	3.5	4.2
	110	4.2	4.5
0.23 – 0.25	85	3.6	5.5
	120	4.5	6.1
0.30	100	4.2	5.5
	125	5.0	6.4
0.5	150	5.8	7.6
	190	6.4	8.0

### Box 8.8 Detailed sizing of gabion under current attack

The shear stress  $\tau_c$  (N/m<sup>2</sup>) on the revetment should first be determined using Equation 4.159 (in Section 4.3.2.6) or Equation 5.107 (in Section 5.2.1.3).

**A first approach** consists of using the critical shear concept and Shield's approach by determining  $\psi_{cr}$  from Equation 5.103 or 5.104 (see Section 5.2.1.2). The values of  $\psi_{cr}$  are found to be close to 0.14 for stability of horizontal gabions on a river bed (Colorado State University, 1988). For further discussion on the critical shear concept, see Section 5.2.1.3.

When the gabion is placed as a revetment on a bank, only part of the gravity force acts as a stabilising force, so the value of  $\tau_{cr}$  should be reduced with a correction factor that takes account of the slope angle  $\alpha$  and the angle of repose,  $\phi$ , of the granular filling in the gabions (see Equations 5.114 to 116).

Where the flow is not purely unidirectional, ie because of oscillation, correction may be found by using Equation 5.108 (Section 5.2.1.3).

**Generalised approaches** are found in Section 5.2.3.1 for sizing of gabions used as bed protection and bank protection. In particular, see Equation 5.219 and Equation 5.223 in Section 5.2.3.1 (only applicable for turbulence intensities,  $r > 0.15$ ).

### Step 2: Residual velocity under the gabion protection and filter design

The designer should ensure that the ground under the gabion protection is not eroded by residual velocity of water. The velocity of the water under the gabion depends on the slope of

the channel, and on the size of the voids between the stones. For steep longitudinal slopes, the residual velocity under a gabion mattress may be higher than the allowable velocity of the underlying soil. A geotextile filter is generally required under gabions to minimise the risk of erosion (see Section 5.4.3.6).

### Step 3: Estimation of deformation

When the shear stress reaches the critical value for the condition of initial movement of the gabion box, part of the stone moves downstream inside each compartment of the gabion mattress. If the stress further increases, one of the two following scenarios may occur:

1. The gabion loses effectiveness because the base soil under the mattress is exposed to water action, which may result in erosion.
2. A new equilibrium is reached, in which the strength of the steel wire mesh allows it to fulfil its containment function.

If the designer allows a small deformation of mattresses, the allowable shear strength can be improved by nearly 20 per cent.

### Design and sizing of gabion revetments subject to wave action

A gabion revetment can be used for protection against small waves (smaller than 1.50 m) in estuaries or ship-induced waves or wind generated waves on lakes. Tests performed by Delft University (1983) enabled acceptable wave heights to be determined for gabion revetments, depending on the riverbank slope and on the revetment thickness (see also Section 5.2.2.7 and Section 5.2.2.8). The minimum thickness  $t_{min}$  (m) of a gabion revetment can be determined by the Equations 8.6 and 8.7 (see also Pilarczyk, 1998):

$$t_{min} = \frac{H}{2\Delta(1-n_v)\cot\alpha} \quad \text{for } \cot\alpha \leq 3 \quad (8.6)$$

$$t_{min} = \frac{H}{4\Delta(1-n_v)(\cot\alpha)^{1/3}} \quad \text{for } \cot\alpha > 3 \quad (8.7)$$

where  $H$  = design wave height (m) (generally the significant wave height  $H_s$ ),  $\Delta$  = relative buoyant density of the stone,  $\alpha$  = slope angle of the bank,  $n_v$  = porosity of revetment material, with a typical value of 0.35 (see Section 3.14.3).

## 8.6.2.4

### Transitions

#### Transition to armourstone revetments

Transitions between gabion mattresses and armourstone revetments are achieved by having an overlap of a layer of armourstone on the mattresses. As a consequence, continuity of hydraulic protection is ensured as shown in Figure 8.57 (see also Section 8.2.7.6).

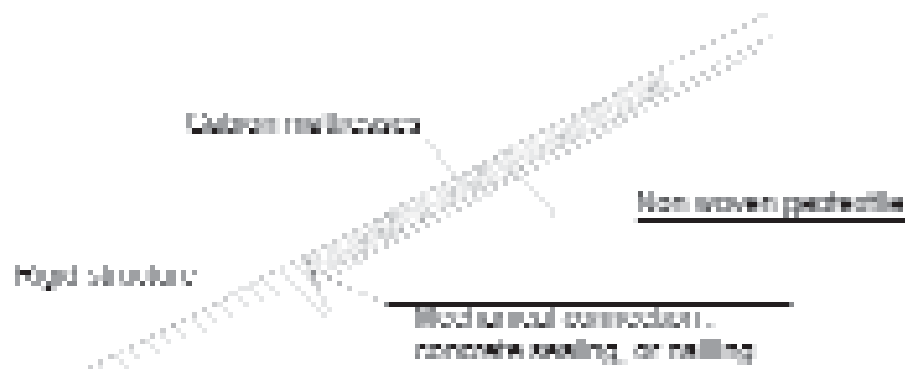


**Figure 8.57** Transition between gabion revetment and armourstone (courtesy Maccaferri, France)



### Transition with rigid body

A transition to a rigid body may exist when a gabion is in contact with a concrete revetment or the bed rock. Where there is a rigid revetment, the gabion needs to be mechanically linked by using either concrete embedding or by nailing (see Figure 8.58).



**Figure 8.58** Transition between gabion revetment and rigid structure (courtesy Maccaferri, France)

#### 8.6.2.5 Materials Issues that Influence design

A gabion revetment is composed of three elements: wire gabion box, filling stones and generally underlying filter that is usually a geotextile filter. The advantage of gabions is that, for the same hydraulic conditions, they allow river training works to be constructed using smaller stones and smaller quantities than required for rip-rap. Characteristics of stones and wires for gabion may be found in the French standard NF P 94-325-1 or in Section 3.14. The following points are a summary of essential requirements:

- **gabion wires:** To increase durability, steel wires should be protected from corrosion risks. Steel should be highly galvanised with galfan or similar product and/or covered with plastic coating
- **filling stones:** The materials used should conform to the specifications of EN 13383. Filling stone of standard grading CP<sub>90/180</sub> is recommended for box gabions. Declared grading CP<sub>90/130</sub> is recommended for gabion mattresses (see Section 3.4.3.9 for non-standard gradings). Either rounded or quarried stones may be used as fill material
- **underlying geotextile:** to avoid residual erosion, a geotextile should always be placed under gabion revetments. It should be chosen in accordance with the subsoil particle size and hydraulic loads on the revetment. Generally a non-woven geotextile using polyester and/or polypropylene with a weight between 130 and 230 g/m<sup>2</sup> can be used (see Section 5.4.3.6 and Section 3.16 for further information).

#### 8.6.2.6 Construction Issues that Influence design

There are two main options for construction using gabions and mattresses as shown in Figure 8.59. They are:

- linked and filled directly on the bank in dry conditions when possible
- filled on the bank and then placed with a crane below the water level.

Gabions are often mechanically filled, with little labour. It is possible to reach good productivity for works in dry conditions with an average ratio of 200 m<sup>2</sup> of protection per day, for a team of five people with a standard excavator.



**Figure 8.59**  
*Construction of gabion  
 revetments in wet or dry  
 conditions (courtesy  
 Maccaferri, France)*

Further discussion is provided in Section 9.7.1 on construction and placing of gabions.

#### **8.6.2.7 Maintenance issues that influence design**

General considerations on maintenance are presented in Chapter 10. The durability of gabion revetments depend on the aggressiveness of the environment. In normal conditions and correctly built with highly protected steel wires, they can be as durable as concrete or composite revetments. When used in appropriate conditions, gabion revetments do not need any specific maintenance, except occasional vegetation cutting.

In highly abrasive conditions, the exposed facing gabions may be replaced by another roll of mesh, which is linked to the gabion base.

Table 8.12 lists possible causes of damage to gabions and associated methods to limit or repair them.

**Table 8.12** Causes of damages to gabions, their effects and measures to limit damage or repair gabions

Feature	Cause	Effect	Design measure
Hydraulic actions	Unacceptable wave heights	<ul style="list-style-type: none"> <li>displacement of filling stones</li> <li>loss of hydraulic resistance</li> </ul>	<ul style="list-style-type: none"> <li>appropriate design method</li> <li>provide additional protection of gabions using bituminous or concrete grouting</li> </ul>
	Unacceptable water flow velocity	<ul style="list-style-type: none"> <li>displacement of filling stones</li> <li>loss of hydraulic resistance</li> </ul>	<ul style="list-style-type: none"> <li>adopt appropriate design method</li> </ul>
	Abrasion by gravel or cobbles in the flow	Abrasion of steel wire – possible breakage of wire mesh	<ul style="list-style-type: none"> <li>provide additional protection to the exposed gabion face using bituminous or concrete grouting or concrete surface</li> <li>use larger diameter steel wire</li> </ul>
Biological	Vermin	Limited impact because of the use of wire mesh	None
	Plant growth	Modification of hydraulic performance of revetment and increased hydraulic roughness	<ul style="list-style-type: none"> <li>vegetation control if necessary</li> <li>planting of appropriate vegetation species</li> </ul>
Chemical	Aggressive water or environment such as acid, sodium chloride	High corrosion rate of steel wire	Protect by Al-Zn galvanising and plastic coating
Climate	Freeze/Thaw	Spalling of filling stones	Use good quality and durable filling stones
Human action	Vandalism or theft	Cutting and removal of steel wire mesh	<ul style="list-style-type: none"> <li>provide protective cover to gabions eg by using earth grouting and vegetation cover</li> <li>use larger diameter steel wire</li> </ul>
	Washing places	Little impact because of the integrity of gabion structures	None
Traffic	Ship/bank collision	Local destruction of revetment	<ul style="list-style-type: none"> <li>allow for easy repair</li> <li>replace or repair damaged area with new stones and mesh</li> <li>provide additional protection layer</li> </ul>
	Dragging anchors	Local destruction of revetment	<ul style="list-style-type: none"> <li>allow for easy repair</li> <li>replace or repair damaged area with new stones and mesh</li> <li>provide additional protection layer</li> </ul>
Ultra-violet light	Sunlight	Loss of strength and degradation on plastic coating of wire	Use a stabilised polymer such as PVC or XPE

## 8.7 REFERENCES

- BAW (Bundesanstalt für Wasserbau) (1990). *Code of practice – Use of Cement-bonded and Bitumen-bonded materials for grouting armourstone on Waterways*. MAV, Karlsruhe, Bundesanstalt für Wasserbau
- Bonasoundas, M (1973). *Stromungsvorgang und Kolkproblem am runden Brückenpfeiler [Flow structure and problems at circular bridge piers]*. PhD thesis / Report no. 28, Oskar V. Miller Institute, Technical University, Munich [in German]
- CUR/TAW (1991). *Guide for the design of riverdikes volume 1 – upper river area*. CUR, Gouda, pp 59-65
- Delft Hydraulics (1973). *Improvement of the navigability of the river-canal crossing near Wijk bij Duurstede, The Netherlands; morphological aspects*. Delft Hydraulics report M974-975 (in Dutch)
- Delft University (1983). *Hydraulic response to wind and ship induced waves for channel and coastal design*, Delft University Press, Delft
- Environment Agency (1999). *Waterway bank protection: a guide to erosion assessment and management*. R&D Publication 11, The Stationary Office, pp105
- Escarameia, M (1998). *Design manual on river and channel revetments*. Thomas Telford, London
- Hemphill, R W and Bramley, M E (1989). *Protection of river and canal banks*. CIRIA report, Butterworths, London
- Hjorth, P (1975). *Studies on the nature of local scour*. Bulletin Series A, No. 46, 1975. Dept. Water Resources Engineering, Lund Institute of Technology, University of Lund, Sweden
- Hoffmans, G J C M and Verheij, H C (1997). *Scour manual*. AA Balkema, Rotterdam, The Netherlands, 205 pp, ISBN 9054106735
- IAHR (1980). *Working group on ice forces on structures*. Special report 80 –26, June
- Jansen, P, Ph, Van Bendegom, L, Van Den Berg, M, De Vries, M and Zanen, A (1994). *Principles of river engineering; The non-tidal alluvial river*. Pitman, London, ISBN: 9040712808
- Larinier, M, Porcher, J P, Travade, F and Gosset, C (1994). *Passes à poisons, expertise, conception des ouvrages de franchissement collection mise au point*. Conseil Supérieur de la Pêche, 336 pp
- LCPC (1989). *Les enrochements*. Ministère de l'Équipement, Paris, 106 pp
- Mamak, D W (1958). *River regulation*. (translated and re-print of publication in Polish), Office of Technical Services, US Dep of Commerce, Washington
- May, R, Ackers, J and Kirby, A (2002). *Manual on scour at bridges and other hydraulic structures*. CIRIA, C551, London
- McDonald, G N (1988). “Riprap and armour stone”. In: A C T Chen and C B Leidersdorf (eds), *Arctic coastal processes and slope protection design: a state of the practice report*. Technical Council on Cold Regions Engineering Monograph, ASCE, New York, pp 190–207
- PIANC (1987a). *Guidelines for the design and construction of flexible revetments incorporating geotextiles for inland waterways*. InCom Working Group 04, Supplement to PIANC Bulletin No 57, Brussels
- PIANC (1987b). *Risk consideration when determining bank protection requirements*. InCom Working Group 03, Supplement to PIANC Bulletin No 58, Brussels
- Pilarczyk, K W (1998). *Dikes and revetments: design, maintenance and safety assessment*. AA Balkema, Rotterdam
- Rajaratnam, N (1976). *Turbulent jets*. Elsevier Scientific Publishing Company, Amsterdam and New York, 304 pp
- Simons, D B (1984). *Hydraulic test to develop design criteria for the use of reno mattresses*. Water Resources Archive, Colorado State University, Fort Collins

- Sumer, B M and Fredsoe, J (2002). “The mechanics of scour in the marine environment”. Technical University of Denmark, *Advanced Series in Ocean Engineering* – Vol. 17
- Tappin, R G R, Van Duivendijk, J and Haque, M (1998). “The design and construction of the Jamuna, Bridge in Bangladesh”. In: *Proc. Institution of Civil Engineers, London*
- TAW (Technical Advisory Committee on Water Defences) (1985). *The use of asphalt in hydraulic engineering*. Rijkswaterstaat Communications, no 37, The Hague
- UK River Restoration Centre (1999). *Manual of river restoration techniques*. Updated in 2002, available from <http://www.therrc.co.uk>
- USACE (1981). *The stream bank erosion control evaluation and demonstration act of 1974*. Main report, USACE, US
- Van der Hoeven, M A (2002). *Behaviour of a falling apron*. MSc Thesis, TU Delft
- Wuebben, J L (1995). “Ice effects on riprap”. In: C R Thorne, S R Abt, F B J Barends, S T Maynard and K W Pilarczyk (eds), *River, coastal and shoreline protection: erosion control using riprap and armourstone*. John Wiley & Sons, Chichester, ch 31, pp 513–529
- Winter, H V, and Van Densen, W L T (2001). “Assessing the opportunities for upstream migration of nonsalmonid fishes in the weir- regulated River Vecht”. *Fisheries Management and Ecology* Volume 8, 513-532 pp
- WL|Delft Hydraulics (1998). *Samengestelde overlaten, vispassages Driel, Amerongen en Hagestein*. Project Q2393, WL|Delft Hydraulics, Delft

1

2

3

4

5

6

7

8

9

10

